



Normal Procedures Checklist

FAA APPROVED

10-17-07

Before Starting Engines

WARM LIGHT AS REQUIRED
 RUDDER PEDALS and SEATS ADJUSTED and LOCKED ‡
 WINDOWS CLOSED and LOCKED ‡
 O₂ MASKS / REGULATORS / INTERPHONE / GOGGLES / O₂ PRESSURE SET and CHECKED ‡
 IRS PANEL (if installed) NAV / LTS OUT
 AHRs COMPASS CONTROLLERS (if installed) SLAVED
 EMERGENCY LIGHTS ARMED
 PROBE HEAT CAPT
 WINDSHIELD ANTI-ICE ON or A-ICE
 PRESSURIZATION AUTO (up) and SET
 FLIGHT GUIDANCE PANEL SET and CHECKED
 FLT INSTR / SWITCHES / BUGS SET and CROSSCHECKED ‡
 FUEL PANEL / QUANTITY and DISTRIBUTION SET / ___ LBS and CHECKED
 GEAR HANDLE and LIGHTS DOWN, THREE GREEN
 GFMS / FMS DATA INSERTED
 TRANSPONDER TA / RA and SET
 STABILIZER TRIM SET
 SPOILER LEVER RET
 TAKEOFF WARNING CHECKED ‡
 THROTTLES CLOSED
 FUEL LEVERS OFF
 FLAPS / SLATS UP / RET
 AILERON / RUDDER TRIM ZERO / ZERO
 PARKING BRAKE / PRESSURE PARKED / NORMAL
 F/A BRIEFING COMPLETED
 TAKEOFF BRIEFING COMPLETED

Ten Minutes Prior to Departure

SEAT BELT SIGNS ON
 ACARS FUEL / APU HOURS UPDATED
 LOG BOOK and FLIGHT FORMS ON BOARD / REVIEWED / ACFT NO. ___ ‡

Prior to Engine Start or Pushback

FUEL PUMPS ON
 AUX HYDRAULIC PUMP ON
 ANTI-COLLISION / EXTERIOR LIGHTS ON / AS REQUIRED
 DOORS CLOSED
 CABIN READY REPORT RECEIVED
 COCKPIT DOOR CLOSED and SECURED
 SHOULDER HARNESSSES ON ‡

Taxi

ENGINE ANTI-ICE AS REQUIRED

Before Takeoff

Use Mechanical Checklist

After Takeoff - Climb

GEAR UP, NO LIGHTS
 SPOILER LEVER DISARMED
 AUTO BRAKE OFF / DISARMED
 FLAPS / SLATS UP / RET, NO LIGHTS
 ENGINE IGNITION AS REQUIRED
 PRESSURIZATION and AIR CONDITIONING CHECKED
 APU AS REQUIRED

10,000 Ft MSL

FUEL SYSTEM CHECKED
 ANNUNCIATOR PANEL CHECKED
 HYDRAULIC PUMPS LOW / OFF
 PRESSURIZATION and AIR CONDITIONING CHECKED
 STERILE COCKPIT (10,000 Ft AFL) CHIME

Approaching Transition Altitude

ALTIMETERS SET, 29.92 and CROSSCHECKED
 Set BARO to QNE (29.92).

18,000 Ft MSL (or FL 180)

EXTERIOR LIGHTS AS REQUIRED
 AIRCRAFT PERFORMANCE CHECKED

Cruise

ENGINE and AIRPLANE SYSTEMS CHECK
 ENGINE SYNC AS REQUIRED
 FUEL SYSTEM AS REQUIRED
 ART SWITCH AUTO
 FLAP T.O. SEL WHEEL 23°
 ALTIMETERS (RVSM Airspace only) CHECK / RECORD
 POSITION REPORT AS REQUIRED



Descent

MAINTENANCE / SERVICE
 ITEMS SEND ARMS CODES
 LANDING DATA PREPARED
 PRESSURIZATION SET and CHECKED
 ENGINE SYNC OFF
 ANTI-ICE AS REQUIRED
 WINDSHIELD ANTI-FOG AS REQUIRED
 EGPWS (TERR DISPLAY) AS REQUIRED

Approaching Transition Level

ALTIMETERS SET, XX.XX and
 CROSSCHECKED
 Set BARO to QNH.

**FL 180 (or 18,000 Ft MSL) or Leaving
 Cruise Altitude, Whichever Is Lower**

EXTERIOR LIGHTS AS REQUIRED
 HYDRAULIC SYSTEM HI / ON / CHECKED
 SHOULDER HARNESSSES ON

10,000 Ft MSL

STERILE CHIME
 (10,000 Ft AFL) ACCOMPLISHED
 LANDING PA ACCOMPLISHED
 APPROACH BRIEFING ACCOMPLISHED

Before Landing

Use Mechanical Checklist

After Landing - Taxi

LANDING LIGHTS RET
 SPOILER LEVER RET
 AUTO BRAKE OFF / DISARMED
 ENGINE IGNITION OFF
 FLAPS / SLATS UP / RET, NO LIGHTS
 RADAR OFF
 APU AS REQUIRED
 PNEU X-FEEDS OPEN
 RIGHT ENGINE
 (for one engine taxi) SHUT DOWN
 OVERWING HEATER
 SWITCH AS REQUIRED

Parking

On flights with no crew change or when incoming crew is met by outgoing crew, check only boxed items.

BRAKES PARKED
 SEAT BELT SIGNS OFF
 APU or EXTERNAL POWER ESTABLISHED
 FUEL LEVERS OFF

ANTI-COLLISION / EXTERIOR LIGHTS ... OFF /
 AS REQUIRED
 ENGINE IGNITION OFF
 FUEL PUMPS AS REQUIRED
 EMERGENCY LIGHTS OFF
 PROBE HEAT OFF
 ANTI-ICE OFF
 AIR CONDITIONING AS REQUIRED
 OIL / HYD / O₂ QTY'S CHECKED
 HYDRAULIC PUMPS HI / OFF
 ARRIVAL REPORT, DELAY CODES, and
 APU HOURS UPDATED
 IRS's (if installed) OFF
 TRANSPONDER STBY
 LOG BOOK COMPLETED

FLIGHT DIRECTORS OFF
 O₂ REGULATOR SUPPLY LEVERS OFF ‡
 COCKPIT LIGHTS AS REQUIRED ‡

**Accomplish only on Overnight Terminations
 after All Passengers Have Deplaned**

GALLEY POWER OFF
 VOLT / AMP INDICATOR
 SELECTOR AS REQUIRED
 AIR CONDITIONING AS REQUIRED
 OUTFLOW VALVE AS REQUIRED
 RECIRCULATION FAN AS REQUIRED
 APU AS REQUIRED
 BATTERY SWITCH AS REQUIRED
 GROUND SERVICE BUS AS REQUIRED
 O/W HTR SWITCH OFF
 POST FLIGHT INSPECTION AS REQUIRED

Table of Contents

Crew Duties

General 10.1
 Normal Procedures Checklist..... 10.2
 Autoflight / Altitude Clearance Procedures..... 10.3
 GFMS Edits 10.4
 Traffic Watch 10.4
 Pilot-Monitoring 10.4

General Operations

Airspeed References..... 15.1
 Cabin Door Operation 15.1
 Anti-Collision Lights..... 15.1
 Nosewheel Landing Gear Spray Deflectors 15.2
 During Taxi 15.2
 Precautions at Airports with Military Arresting Gear 15.2
 Use of Redundant Systems 15.2
 Use of VHF Comm Radio..... 15.2
 Special Equipment List (SEL)..... 15.2
 Standardized Litany 15.3

Airplane Flight Control Characteristics

Transport Aircraft Flight Controls 20.1
 General..... 20.1
 Ailerons / Spoilers 20.1
 Rudders..... 20.1
 Rudder Limiters 20.2
 Rudder Reversals..... 20.3
 Sideslip Angle..... 20.3
 Vertical Stabilizer Loading..... 20.4
 Summary 20.4
 Use of Rudder on Transport Category Airplanes 20.5
 Rudder Maneuvering Considerations..... 20.5
 Design Maneuvering Speed – Va..... 20.7
 Certification Requirements 20.8
 Vertical Stabilizer Load Design..... 20.9
 Rudder Limiter..... 20.10
 Recommendations 20.11
 Summary 20.12

Upper Wing Clear Ice / Frost

General	25.1
---------------	------

Cold Weather Operations

General	30.1
FAR	30.1
Operating Manual References	30.1
Deicing / Anti-Icing Description	30.1
One Step Deicing	30.1
Two Step Deicing / Anti-Icing	30.1
Fluid Types	30.2
Type I	30.2
Type II and Type IV	30.2
Hot Water	30.2
Other Deicing Methods	30.3
Forced Air	30.3
Infrared Radiant Heat	30.3
Determination of Holdover Time (HOT)	30.3
Level of Deicing / Anti-Icing Required	30.4
Pre-Flight Procedures	30.4
Deicing / Anti-Icing Procedures	30.6
Deicing / Anti-Icing at Off-Line Stations	30.6
Ground to Cockpit Communications	30.7
Gate Departure	30.9
Off Gate Deicing	30.9
Pushback Start	30.9
Powerback	30.10
Engine Start	30.10
After Starting Engines	30.10
Taxi	30.10
Holdover Tables and Pre-Takeoff Checks	30.12
Visual Indications of Loss of Fluid Effectiveness	30.13
Type I Fluid	30.14
Type II and Type IV Fluid	30.14
Pre-Takeoff Contamination Check Conducted	
Outside the Airplane	30.14
Operations in Ice Pellets	30.14
Allowance Time vs. Holdover Time	30.15
Time of Fluid Effectiveness with Imbedded Ice Pellets	30.15
Ice Pellet Allowance Times Table	30.16

Pilot Assessment of Precipitation Intensity.....	30.17
General.....	30.17
Procedure.....	30.17
Drizzle / Freezing Drizzle and Rain / Freezing Rain.....	30.18
Ice Pellets.....	30.18
Precipitation Intensity Assessments by Other Qualified External Observers.....	30.19
Snowfall Intensity as a Function of Visibility.....	30.19
Takeoff	30.20
Climb, Enroute, Holding and Approach.....	30.20
Landing	30.20
Taxi-In and Parking	30.21
Overnight Parking in Sub-Freezing Temperatures.....	30.21

Cold Weather Operations Tables

Fluid Holdover Tables	31.1
FAA Type I	31.1
FAA Type II	31.2
KILFROST ABC-2000 Type II	31.3
FAA Type IV	31.4
UCAR ULTRA+ADF / AAF Type IV	31.5
UCAR ENDURANCE EG106 Type IV	31.6
UCAR FLIGHTGUARD AD-480 Type IV	31.7
OCTAGON MAX-FLIGHT 04 Type IV	31.8
KILFROST ABC-S Type IV.....	31.9
KILFROST ABC-S PLUS Type IV	31.10
LYONDELL ARTIC SHIELD Type IV.....	31.11
SAFEWING MP IV 2001 Type IV	31.12

Crew Duties

General

Normally, crew duties are divided between Captain and First Officer during ground operations and between pilot-flying (PF) and pilot-monitoring (PM) during flight. Although crew duties are divided, each pilot should always maintain an awareness of the other pilot's activities.

Specific duties are assigned to each crewmember so that maximum crew coordination and efficiency may be maintained regardless of changes in crew pairings.

Pre-Flight Inspection will normally be accomplished by the First Officer. However, at Captain's discretion, Pre-Flight Inspection may be accomplished by either pilot individually, or it may be split between the two pilots.

Inflight, the concern of one pilot will be directed primarily to control of the airplane. Captain will designate which pilot is responsible for flying the airplane and that pilot will not perform any duties which could or would detract from this primary responsibility.

Unless a particular procedure specifies otherwise, whenever pilot-flying wishes to transfer control of airplane to pilot-monitoring, pilot-flying will state to pilot-monitoring – *"You have the airplane."* The pilot-monitoring, after taking control of airplane, will state – *"I have the airplane,"* indicating that transfer of control has taken place.

As a general practice, pilot-monitoring will normally accomplish certain duties such as handling of flaps, gear, radio communications, etc.

The First Officer will normally not make gear or flap configuration changes without first obtaining Captain's concurrence.

Inflight if the fuel system is set up for crossfeed and it becomes necessary for either pilot to leave the cockpit, a tank-to-engine configuration shall be established until the other pilot's return.

Normal Procedures Checklist

The Normal Procedures Checklist is used to ensure all important safety items have been accomplished. **The checklist for each phase of flight shall be accomplished as specified in the preface statement preceding each of the expanded checklists.** Where the response "AS REQUIRED" is indicated on the checklist the crewmember responding will state the required status of the item, i.e., On, Off, Standby, Closed, etc.

The Captain is responsible for ensuring that each Normal Procedures Checklist is accomplished at the proper time. Normally, the pilot-monitoring (PM) will accomplish the appropriate checklist (based on phase of flight) and will notify the pilot-flying (PF) when the checklist has been accomplished.

With regard to any checklist item, including mechanical checklist items, the item cannot be considered accomplished (and the switch cannot be moved on mechanical checklist) until all of the expanded procedures associated with that item (shown in the Operating Manual under the item) have been accomplished.

For example, the T.O. BRIEFING / PA item cannot be considered closed out until Captain has completed the T.O. BRIEFING, PA has been made, and Flight Attendants have been chimed, since chiming the F/A's is considered an expansion of the T.O. BRIEF / PA item.

Autoflight / Altitude Clearance Procedures

When the autopilot is engaged, pilot-flying the airplane will normally operate the Digital Flight Guidance System (DFGS) panel.

When the autopilot is not engaged, pilot-flying will normally call for the desired changes (i.e., airspeed, heading, altitude, etc.) to be made to DFGS and the pilot-monitoring will make the requested changes to the DFGS. All changes on the DFGS should be verified on the FMA.

The control of the CDU for the GFMS or FMS could be considered an extension of the DFGS when operating in NAV or VNAV or PERF and should be verified on the FMA, PFD or ND, as appropriate. An adequate traffic watch must be maintained while conducting any "head down" operation.

A certain amount of flexibility in this concept is understandable as determined by flight conditions, workload and traffic watch requirements.

Both pilots should be aware of all traffic communications and clearances.

Upon receipt of an altitude clearance, pilot-monitoring will normally set the clearance altitude on DFGS panel and then point to the ALT Preselect Readout until the other pilot verbally acknowledges that the setting agrees with clearance by stating clearance altitude and verifies the FMA altitude is armed.

If there is any question regarding the altitude clearance, it should be verified with ATC.

The pilot-flying will advise pilot-monitoring when leaving one assigned altitude for another. For altitude changes when only one crewmember is at the controls, pilot-flying will advise the other crewmember of the change when he or she returns to cockpit.

When given a climb or descent clearance, if using the altitude capture mode of autopilot / flight director, monitor altitude capture mode to ensure that commands for a smooth level-off at the assigned altitude are being followed.

If autopilot / flight director altitude capture mode is not being used, climb or descend as rapidly as practicable until 1000 feet above or below the assigned altitude. Thereafter, rate of climb or descent should not exceed 1000 feet per minute for the remaining 1000 feet.

When approaching within 1000 feet of the clearance altitude, pilot-monitoring will state, e.g., "23 for 24 armed (or captured)" and pilot-flying will verbally acknowledge "armed (or captured)" and **both pilots will monitor the level-off.**

GFMS Edits

When either pilot modifies GFMS or FMS data, that pilot will advise the other pilot before allowing the airplane to navigate using the modified data. For changes when only one crewmember is at the controls, the pilot-flying will advise the other crewmember of the change when he or she returns to the cockpit.

Traffic Watch

A traffic watch shall be maintained by both crewmembers during all phases of flight, if visual, including taxi, except as necessary to accomplish in-cockpit duties. The Captain shall insure that at least one crewmember's primary duty is to maintain a traffic watch.

Pilot-Monitoring

The term "pilot-monitoring" better characterizes the role of the pilot-not-flying by emphasizing what the pilot is doing rather than by what the pilot is not doing.

Effective monitoring and cross-checking can be the last line of defense that prevents an accident because detecting an error or unsafe situation may break the chain of events leading to an accident. It is a primary responsibility of each crewmember. The pilot-flying (PF) will monitor / control the aircraft, regardless of the level of automation used and the pilot-monitoring (PM) will monitor the aircraft and actions of the PF. Although important in all phases of flight, critical phases of flight requiring increased monitoring occur during airport surface operations and vertical segments of flight.

General Operations

Airspeed References

All airspeed references, unless otherwise noted, refer to Indicated Airspeed (IAS) on the Captain's Airspeed Indicator.

Cabin Door Operation

The task of closing the cabin door for departure and opening the cabin door on arrival is assigned to the Agent, using the cabin door exterior control. Except for emergencies, if a door needs to be reopened before departure, do not request the Flight Attendant to do so. If you can't get the Agent's attention or the Agent is not available, use the radio and request that Gate Control call the gate and advise that an Agent be sent to the jet bridge to open the door.

If a door cannot be verified as locked (door annunciator light illuminated) just prior to or after leaving the gate, at the Captain's discretion and with the airplane parked, a crewmember may go to the cabin to assist the Flight Attendant in locking the door. After assuring that the evacuation slide is not armed, the crewmember (but not Flight Attendant) may cycle the door if it is determined that such action is required to lock the door. The evacuation slide should then be rearmed.

To provide for negative pressure relief, the cabin doors are rigged for a slight gap between the door and airframe when it is closed and the airplane is unpressurized. Therefore, during pre-flight and prior to takeoff, when a door is closed it is normal to see a gap between it and the airframe. As the airplane pressurizes during the takeoff roll, the doors will become flush with the airframe.

WARNING

When attempting to open a cabin door, if the Internal Door Handle cannot be moved, is difficult to move, or the door cannot be opened after moving the handle, do not attempt to use force. Either of these conditions may indicate that the airplane is pressurized. Ensure that the airplane is de-pressurized before attempting to open a cabin door.

Anti-Collision Lights

The anti-collision lights, when operative, shall be on when engines are about to be started or are running, and anytime the airplane is in motion, taxi or tow.

Nosewheel Landing Gear Spray Deflectors

During Taxi

If the airplane has taxied over a rigged arresting cable, or any other large object or structure (i.e., chock), make an entry in the E6 requesting that the nosewheel landing gear spray deflector be inspected.

Precautions at Airports with Military Arresting Gear

Arresting gear installations may be found at airfields used jointly by military and civilian operators.

The energy with which a rigged (raised for operation) arresting cable rebounds after being rolled over is generally proportional to the aircraft speed. The cable rebound may cause damage such as fractures or mis-alignment of the nosewheel landing gear spray deflector. If damage of this nature occurs, and goes undetected, the nosewheel could wedge or jam during retraction and subsequently prevent normal extension.

To prevent exposure to such damage:

- Do not operate on runways with rigged arresting gear (i.e., request use of an alternate runway).
- Request that the cable be lowered or de-rigged.

Use of Redundant Systems

When redundant systems are installed, use system 1, A, or L if the Captain is the pilot-flying and system 2, B, or R if the First Officer is the pilot-flying.

The DFGC 1-2 Switch is normally selected to the side of the pilot-flying. The DFGC and redundant systems must match to comply with RVSM procedures.

Use of VHF Comm Radio

It is standard procedure to use VHF-1 for ATC communications and VHF-2 for company communications.

VHF-1 is powered by the Emergency DC Bus which allows uninterrupted communications and frequency display in the event normal electrical power is lost.

Special Equipment List (SEL)

The Special Equipment List (SEL) for an airplane is included on the Flight Plan / Release, and indicates equipment unique to the airplane. For descriptions of all DC-9 SELs, refer to SYSTEMS – Special Equipment List (SEL) Items.

Standardized Litany

	Takeoff	2 Engine Go-Around	Takeoff Engine Failure	1 Engine Go-Around
	"Autothrottle -ON"	"Go-Around" "Flaps - 15" (or "Flaps 11" as required)	"Autothrottle - ON"	"Go-Around Flaps 11"
80 kts	"80 kts"		"80 kts"	
V ₁	"V1"		"V1"	
V _R	"Rotate"		"Rotate"	
V ₂	"V2"		"V2"	
V ₂ + 10	"V2 +10"			
Positive Rate	"Positive Rate, Gear Up"	"Positive Rate, Gear Up" "Set and Arm Missed Approach Altitude"	"Positive Rate, Gear Up"	"Positive Rate, Gear Up" "Set and Arm Missed Approach Altitude"
400 ft AFL	"HDG SEL" or "NAV"	"HDG HOLD, NAV"	"Runway HDG, HDG SEL"	"Runway HDG, HDG SEL"
500 ft AFL	"Autopilot ON" (if desired)	"Autopilot ON" (if desired)	"Autopilot ON" (if desired)	"Autopilot ON" (if desired)
EOAA 0/EXT 0/RET			"Altitude Hold" "Flaps Up" "Slats Retract"	
1000 Ft AFL 0/EXT	"Half Rate" "Climb Power" "Flaps Up" (on schedule)	"Half Rate" "Climb Power" "Flaps Up" (on schedule)		"Altitude Hold" "Flaps Up" (on schedule)
0/RET	"Slats Retract"	"Set Speed 200, SPD SEL"		"Slats Retract"
0/RET + 20			"IAS" "A/C Override" "MCT" "Checklist"	"IAS" "A/C Override" "MCT" "Checklist"
Clean Min Maneuver	"IAS, Bank 30"			
2500 ft AFL	"IAS 250" or "SPD SEL 250" or "PERF" or "VNAV"			

Cold Weather Operations

General

Outside air temperatures of 40°F (5°C) or colder are considered cold weather operations. Cold weather operating conditions present special considerations which require some basic precautions, compliance with special procedures and attention to detail.

FAR

FAR 121.629 states: "No person may take off an aircraft when frost, ice or snow is adhering to the wings, control surfaces, propellers, engine inlets, or other critical surfaces." FAA Advisory Circular (AC) 20-117 permits up to one-eighth inch of frost on the bottom of the wing under the fuel tank.

Operating Manual References

LIMITATIONS: Ice & Rain

SYSTEMS: Ice & Rain

Deicing / Anti-Icing Description

Deicing is the process by which frost, ice, or snow is removed from the airplane. **Anti-icing** provides protection against accumulation of frost, ice or snow on treated surfaces for a limited time after fluid application.

When airplane surfaces are contaminated (other than thin frost on the upper fuselage), they must be deiced prior to takeoff. If conditions are conducive to the subsequent formation of ice, frost or snow, the airplane critical surfaces must also be anti-iced.

One Step Deicing

Deicing removes frost, ice, or snow from the airplane. When airplane surfaces are contaminated, they must be deiced prior to takeoff. If the airplane is contaminated (e.g., overnight frost), but icing conditions no longer exist, deicers may deice airplanes, but anti-icing is not necessary. Airplane is deiced with heated Type I fluid (or Type II or Type IV outside the U.S.). Hot water may be used to remove wing ice when the ambient temperature is 5°C (40°F) or above and no active precipitation is present or forecast. In these cases, the flight crew will verify that the surfaces are clear of contamination during normal pre-flight. The Captain is the final judge as to whether anti-icing is needed.

Two Step Deicing / Anti-Icing

Anti-icing provides protection against accumulation of frost, ice or snow on treated surfaces for a limited time after fluid application. If conditions are conducive to the subsequent formation of ice, frost or snow, the airplane critical surfaces must also be anti-iced. The airplane is first deiced with Type I (or Type II or Type IV outside the U.S.), followed by anti-icing the critical surfaces with Type I, Type II or Type IV.

It is important to note that anti-icing can only occur in a two-step process.

The critical surfaces that are anti-iced include:

- Wing leading edges and upper surfaces
- Horizontal stabilizer and elevator upper surfaces
- Vertical stabilizer and rudder.

Fluid Types

There are four types of fluids AA uses for deicing / anti-icing: Type I, Type II, Type IV and hot water.

Type I

Heated Type I is normally used for **deicing**. It does have **anti-icing** properties, however, the holdover times are relatively short and only apply after the second application of Type I fluid. The authorized deicer will select the proper mix ratio (fluid concentrate / water). At some stations, Type I fluid with a mix ratio less than 50 / 50 may be used.

Type II and Type IV

Type II (non-domestic stations only) and Type IV are also glycol based, but contain thickening agents. These fluids are designed to shear off during the takeoff roll. The thicker film provides longer holdover times because it can absorb more freezing precipitation before it loses its effectiveness. Type II and Type IV are normally used for anti-icing and are normally applied cold and undiluted. Type IV has a longer holdover time than Type II. Outside the U.S., Type II and Type IV may be diluted and heated to remove contamination from the airplane (one step deicing / anti-icing).

Type II or Type IV may be applied to the fuselage for overnight or extended thru / turn-around protection. It must be flushed off before departure if its holdover has expired (fluid contaminated by snow or freezing precipitation).

Anti-icing fluid that has failed must be flushed off. Another coating of anti-icing fluid cannot be applied directly on top of a contaminated film.

If Type II or Type IV is inadvertently applied to the cockpit windows, static ports or pitot tubes it must be flushed off with hot Type I.

Hot Water

Hot water may be used to remove wing ice when the ambient temperature is 5°C (40°F) or above and no active precipitation is present or forecast. There is no holdover time for hot water.

NOTES

- Having an operative Overwing Heater System does not relieve the flight crew of the requirement to check that the airplane surfaces must be free of frost, snow, and ice accumulation, as required by FARs 91.527 and 121.629.
- This visual inspection does not relieve the crew from performing the more stringent requirement of a tactile check if the heater blankets are inoperative and the temperature is between -4°C (25°F) and 10°C (50°F), or frost or ice is present on the lower surface of either main wing fuel tank.
- Frost on the bottom of the wings under the fuel tanks may occur when the fuel temperature is low, the outside air temperature is above freezing and humidity is high. Takeoff with 1/8" frost on the fuel tank underwing surfaces is permitted. Thin frost on the fuselage where surface features are evident is also permitted. Takeoff with frost anywhere else on the airplane is not permitted.
- Check area behind overwing heater for ice runback and lower wing surfaces for icicles
- Landing gear, doors, actuating mechanisms and steering components
- Pitot tubes, static ports and stall warning (AOA) vanes
- Pack inlet and exit doors, outflow valves, pressure relief valves
- Nose gear deflector
- Engines - Inlet ducts, doors and probes, exhaust ducts, and thrust reversers

NOTES

- Engine inlet ducts, doors and probes, exhaust ducts, and thrust reversers must be free of frozen contamination prior to engine start. Frozen contamination may be removed using limited amounts of heated deicing fluid (not hot water).
- The engines shall not be inspected from the ground only. This check requires that the person conducting the inspection elevate himself or herself to a position where the entire inside circumference of the engine inlet / exhaust may be seen. Also the N₁ fan must be checked to ensure that it rotates freely. The crew may be asked to motor the engine so that rotation can be verified. The results of this inspection must be reported to the flight crew.
- The flight crew shall request an inspection of the engine by authorized deicing (or Maintenance) personnel whenever:
 - An airplane is parked for any period of time in icing conditions which could allow ice or snow to accumulate on the top of the fuselage.
 - Any portion of the airplane shows evidence of frozen contamination (other than wing tank frost on the bottom of the wing or thin frost on the fuselage where surface features are evident).
 - Whenever the temperature is at or below freezing and snow, ice or water may have accumulated in the engine inlet.

- Any engine contamination must be removed prior to pushback and subsequent engine start or engine start at the gate.

- Fuselage

Thin frost is acceptable on the upper surface of the aircraft fuselage (above cabin windows) if all sensors and attached components are clear. This frost is usually a uniform white deposit with a fine crystal texture. The acceptable layer of frost must be thin enough to visually distinguish aircraft seams, rivet heads and other fuselage markings on the upper surface, all other contamination must be removed.

After fuselage contamination has been removed with heated Type I fluid, it is not necessary to anti-ice the fuselage. Studies have determined that the latent heat of the Type I fluid, along with the heat of the cabin is enough to prevent contamination reported as light or moderate from adhering to the fuselage surfaces.

- APU inlet and exhaust.

Deicing / Anti-Icing Procedures

Local station deicing procedures are specified in the Deicing Report on the Flight Plan / Release beneath the Field Report. This information is also available in DECS via the SLS*STA (Station code) / DI entry, or by an ACARS MISC 64 entry.

Any time off-gate deicing operations are in effect, the engine inlets must be clear of frozen contamination prior to pushback and subsequent engine start or engine start at the gate. (See Pre-Flight Procedures section concerning engine inspection requirements prior to engine start.)

If Overwing Heater System is inoperative, the follow-up check performed by deicing personnel after deicing must include a **visual and physical feel (pole)** check of upper wing surface. Since ground personnel will not normally know the Overwing Heater System is inoperative, during the initial deicing cockpit-to-ground communication, the Captain must advise that a visual and physical feel (pole) check of the upper wing surfaces is required.

The APU may be operated during deicing.

Deicing can take place with the engines running at idle or shut down, as determined by local station procedures and deicing crews.

If requested to shut down engines when APU is inoperative and no GPU / air cart is available, shut down engine on the side to be deiced first. Prior to deicing other side, crossbleed start that engine then shut down other engine. Refer to SYSTEMS – Engines – Crossbleed Start.

Air Conditioning Supply Switches and APU AIR Switch must be OFF prior to start of deicing and remain OFF until one minute after deicing is completed.

Deicing / Anti-Icing at Off-Line Stations

Request deicing through Dispatch. Dispatch will contact the Maintenance Operation Center (MOC), who will arrange for deicing through a qualified local provider. MOC will also provide the deicer with AA's procedures, including required post deicing checks. If no qualified provider is available, MOC will arrange to have a qualified AA representative supervise deicing.

The Captain will use the fluid application start time, duration of active precipitation and the applicable table to determine the expiration of holdover time. The Captain can adjust the holdover expiration time (increase or decrease) as required for changing weather conditions. For example, if conditions were to deteriorate, the original holdover time should be decreased. Conversely, if conditions were to improve, holdover time can be extended, using the column on the holdover tables that most closely describes the actual environmental conditions. Whenever in doubt as to the condition of the anti-icing fluid, perform a Pre-Takeoff Contamination Check.

■ **If takeoff will occur prior to the expiration of holdover time:**

A **Pre-Takeoff Cockpit Check** must always be accomplished when icing conditions exist. It is accomplished by the flight crew from inside the cockpit, and consists of visually checking representative surfaces such as the windshield wipers and cockpit window frames for contamination. Based on this check, the Captain will judge whether to takeoff, get deiced again, or perform a Pre-Takeoff Contamination Check.

■ **If takeoff will occur after the expiration of holdover time:**

A **Pre-Takeoff Contamination Check** must be accomplished within five minutes prior to beginning takeoff if the holdover time (as determined by the Captain) has expired. Check the leading edges and upper surfaces of both wings for fluid failure. The check may be accomplished visually by a flight crewmember from the passenger cabin and may be repeated as necessary to meet the five minute before beginning of takeoff requirement.

■ **If aircraft has not been deiced or was one step deiced only:**

If aircraft has not been deiced or was one step deiced only and freezing precipitation begins, a Pre-Takeoff Contamination Check may be performed to determine if takeoff can be accomplished. Takeoff must occur within 5 minutes of check.

Visual Indications of Loss of Fluid Effectiveness

It is difficult to determine when deicing / anti-icing fluid is beginning to fail, however, when any ice or snow can be seen accumulating on treated surfaces, the fluid has lost its ability to absorb frozen contamination. Any ice, frost, or snow (other than ice pellets - see **Operations in Ice Pellets**, this section) on top of deicing or anti-icing fluids must be considered as adhering to the aircraft, and secondary deicing / anti-icing must be accomplished prior to takeoff.

Normally, anti-icing fluid failure will first occur on the leading or trailing edges of the wing rather than the mid-chord. However, when the aircraft is pointing downwind the mid-chord will fail first.

The leading edges and upper surfaces of both wings must be visually checked for evidence of fluid failure.

If the leading edges and upper surfaces of both wings cannot be inspected from the cabin, return for an external Pre-Takeoff Contamination Check conducted by authorized deicing personnel or secondary deicing / anti-icing.

When conducting a Pre-Takeoff Contamination Check at night from the cabin, illuminate the surface being checked through an adjacent window onto the viewing surface to prevent light scatter-back from reducing your ability to clearly view the fluid.

Type I Fluid

When Type I fluid has lost its effectiveness, frozen precipitation will begin to accumulate on the aircraft surface in much the same manner as it would on a non-treated surface.

Type II and Type IV Fluid

When Type II or Type IV fluid has lost its effectiveness and is no longer able to absorb the freezing moisture, look for the following visual indications:

- Gray or white appearance and buildup of ice crystals in or on top of the fluid.
- Progressive surface freezing.
- Snow accumulation.
- Dulling of surface reflectiveness caused by the gradual deterioration of the fluid to slush (loss of gloss or orange peel appearance).
- Ice buildup on the wing life raft attach points (if installed), adjacent to the over-wing exits.

Pre-Takeoff Contamination Check Conducted Outside the Airplane

If conditions require, the Pre-Takeoff Contamination Check may be conducted from outside the airplane by authorized deicing personnel. If ground personnel conducted the check, the deicer will establish ground-to-cockpit communications and advise the status of the check.

The following information must be relayed to the flight deck crew:

- The contamination check has been performed.
 - The aircraft and engines are ready for departure.
- or-
- The aircraft and engines require deicing.

Takeoff must begin within five minutes of the last Pre-Takeoff Contamination Check.

Loss of fluid effectiveness (fluid failure) in periods of freezing drizzle or light freezing rain may be difficult to detect. If any doubt exists concerning the airplane's condition, it must be deiced or a Pre-Takeoff Contamination Check must be conducted from outside the airplane by authorized deicing personnel.

Operations in Ice Pellets

Aerodynamic tests have shown that after proper deicing and anti-icing, the accumulation of light ice pellets in Type IV fluid will shear from the aerodynamic surfaces during takeoff.

- Keep nose wheel firmly on runway with elevator.

CAUTION

An excessive amount of down elevator will download the main gear and reduce braking efficiency.

- Use maximum auto brakes or aggressive manual braking and auto spoilers, if available.
- Maintaining directional control is the highest priority.
- Apply reverse thrust as soon as possible after nosewheel touchdown. Do not exceed 1.3 EPR reverse thrust on the slippery portions of the runway, except in an emergency.
- When reversing, if directional control is lost, reduce reverse until control is regained. Use forward idle thrust if necessary.
- Do not come out of reverse at a high RPM. Sudden transition of reversers before engines spool down will cause a forward acceleration.
- Use as much of the runway for roll-out as needed to slow airplane to a safe taxi speed before turning off a wet / slippery runway.

CAUTION

In an emergency, use maximum reverse thrust, if required, to stop in the remaining runway.

Taxi-In and Parking

In addition to the general taxi precautions listed for taxi-out –

- To reduce the possibility of flap damage after making an approach in icing conditions, or landing on a runway covered with snow or slush, do not retract the flaps / slats to less than 15 / EXT until the flap area has been checked free of debris. Advise station by radio, if possible, or upon reaching gate position, of the need for a check of the flap area. Deicing personnel or flight crew must check the inboard flap wells for snow, ice, or slush accumulation.
- If lead in lines are obscured, ensure adequate Guidemen are available.
- Notify Dispatch if runways, taxiways or ramp conditions are degraded. Use ACARS to report braking action.
- If icy precipitation (snow, ice, frost, freezing rain, sleet, freezing fog, etc.) exists or is anticipated, or if the aircraft is to be de-iced, turn Overwing Heater Switch OFF.

Overnight Parking in Sub-Freezing Temperatures

When parking overnight in subfreezing temperature, water system and toilet tanks must be drained by station personnel. If toilet tanks are not drained, anti-freeze must be added. At off-line stations without AA Maintenance, station personnel or contract maintenance will obtain instructions by calling the airplane Technical Services Group.

Cold Weather Operations Tables

Fluid Holdover Tables

FAA Type I

OAT		Approximate Holdover Times Under Various Weather Conditions (hrs : min)							
°C	°F	Active Frost *	Freezing Fog	Snow / Snow Grains			Freezing Drizzle †	Light Freezing Rain	Rain on Cold Soaked Wing ‡
				Very Light **	Light **	Moderate **			
-3 and above	27 and above	0:45	0:11 - 0:17	0:18 - 0:22	0:11 - 0:18	0:06 - 0:11	0:09 - 0:13	0:02 - 0:05	0:02 - 0:05
Below -3 to -6	Below 27 to 21	0:45	0:08 - 0:13	0:14 - 0:17	0:08 - 0:14	0:05 - 0:08	0:05 - 0:09	0:02 - 0:05	
Below -6 to -10	Below 21 to 14	0:45	0:06 - 0:10	0:11 - 0:13	0:06 - 0:11	0:04 - 0:06	0:04 - 0:07	0:02 - 0:05	
Below -10	Below 14	0:45	0:05 - 0:09	0:07 - 0:08	0:04 - 0:07	0:02 - 0:04			

Holdover times only apply to Type I if two applications have been made, one application for deicing and one application for anti-icing.

No holdover time guidelines exist for snow pellets, ice pellets, heavy snow, moderate and heavy freezing rain, and hail.

* This column refers to conditions of active environmental frost, not frost caused by cold soaked fuel.

** Refer to table Snowfall Intensities as a Function of Visibility.

† Use light freezing rain holdover times if positive identification of freezing drizzle is not possible.

FAA Type II

OAT		Type II Fluid Concentration Fluid / Water	Approximate Holdover Times Under Various Weather Conditions (hrs : min)					
°C	°F		Active Frost *	Freezing Fog	Snow / Snow Grains ***	Freezing Drizzle †	Light Freezing Rain	Rain on Cold Soaked Wing ‡
-3 and above	27 and above	100 / 0	8:00	0:35 - 1:30	0:20 - 0:45	0:30 - 0:55	0:15 - 0:30	0:05 - 0:40
		75 / 25	5:00	0:25 - 1:00	0:15 - 0:30	0:20 - 0:45	0:10 - 0:25	0:05 - 0:25
		50 / 50	3:00 [#]	0:15 - 0:30	0:05 - 0:15	0:05 - 0:15	0:05 - 0:10	
Below -3 to -14	Below 27 to 7	100 / 0	8:00 [#]	0:20 - 1:05	0:15 - 0:30	** 0:15 - 0:45	** 0:10 - 0:20	
		75 / 25	5:00 [#]	0:20 - 0:55	0:10 - 0:20	** 0:15 - 0:30	** 0:05 - 0:15	
Below -14 to -25	Below 7 to -13	100 / 0	8:00 [#]	0:15 - 0:20	0:15 - 0:30			

No holdover time guidelines exist for snow pellets, ice pellets, heavy snow, moderate and heavy freezing rain, and hail.

* This column refers to conditions of active environmental frost, not frost caused by cold soaked fuel.

** No holdover time guidelines exist for this condition below -10°C (14°F).

*** Refer to table Snowfall Intensities as a Function of Visibility.

Radiational cooling during active frost conditions may reduce holdover times when operating close to the lower end of the outside air temperature range.

† Use light freezing rain holdover times if positive identification of freezing drizzle is not possible.

‡ This column is for use at temperatures above 0°C (32°F) only.

FAA Type IV

OAT		Type IV Fluid Concentration Fluid / Water	Approximate Holdover Times Under Various Weather Conditions (hrs : min)					
°C	°F		Active Frost *	Freezing Fog	Snow / Snow Grains ***	Freezing Drizzle †	Light Freezing Rain	Rain on Cold Soaked Wing ‡
-3 and above	27 and above	100 / 0	12:00	1:15 - 2:30	0:35 - 1:15	0:40 - 1:10	0:25 - 0:40	0:10 - 1:05
		75 / 25	5:00	1:05 - 1:45	0:20 - 0:55	0:35 - 0:50	0:15 - 0:30	0:05 - 0:40
		50 / 50	3:00 [#]	0:15 - 0:35	0:05 - 0:15	0:10 - 0:20	0:05 - 0:10	
Below -3 to -14	Below 27 to 7	100 / 0	12:00 [#]	0:20 - 1:20	0:20 - 0:40	** 0:20 - 0:45	** 0:10 - 0:25	
		75 / 25	5:00 [#]	0:25 - 0:50	0:15 - 0:35	** 0:15 - 0:30	** 0:10 - 0:20	
Below -14 to -25	Below 7 to -13	100 / 0	12:00 [#]	0:15 - 0:40	0:15 - 0:30			

No holdover time guidelines exist for snow pellets, ice pellets, heavy snow, moderate and heavy freezing rain, and hail.

* This column refers to conditions of active environmental frost, not frost caused by cold soaked fuel.

** No holdover time guidelines exist for this condition below -10°C (14°F).

*** Refer to table Snowfall Intensities as a Function of Visibility.

Radiational cooling during active frost conditions may reduce holdover times when operating close to the lower end of the outside air temperature range.

† Use light freezing rain holdover times if positive identification of freezing drizzle is not possible.

‡ This column is for use at temperatures above 0°C (32°F) only.

Table of Contents

Pre-Flight Inspections

Preface 10.1

Standardized Scan 10.2

Exterior Safety Inspection 10.3

Cockpit Preparation 10.4

 Cockpit Safety Inspection 10.4

 Cockpit Initial Preparation 10.5

 Cockpit Area Inspection 10.7

Final Cockpit Preparation 10.8

Walk-Around Inspection 10.13

 General 10.13

 Inspection 10.15

Cockpit Clean-up Inspection 10.20

Pre-Flight Inspections

Preface

The Origination Pre-Flight Inspection is accomplished on the first flight of the day for the airplane (first departure after midnight - local time) and anytime the condition of the airplane is in doubt.

The items included in the Origination Pre-Flight Inspection and the recommended sequence of accomplishment is as follows:

- Exterior Safety Inspection
- Cockpit Preparation
 - Cockpit Safety Inspection
 - Cockpit Initial Preparation
 - Cockpit Area Inspection
- Walk-Around Inspection
- Final Cockpit Preparation

On other than the first flight of the day for the airplane, only the following need be accomplished:

- Cockpit Clean-Up Inspection
- Walk-Around Inspection

When there is a crew change, every effort should be made by an outgoing crewmember to meet the airplane on arrival to review the condition of the airplane with the incoming crew.

When maintenance has been performed, the pre-flight item associated with the system, component, etc., should be checked. Also check that any associated c-b's that may have been pulled have been reset.

The Pre-Flight may be accomplished by one pilot individually, or it may be split between the two pilots.

Standardized Scan

Procedures for each phase of flight (Pre-Flight, Before Starting Engines, etc.) follow a standardized scan of the cockpit panels or equipment. Besides standardization, this "scan" (1) enables the flight crew to more rapidly accomplish the required items, and (2) ensures that all necessary actions have been taken.

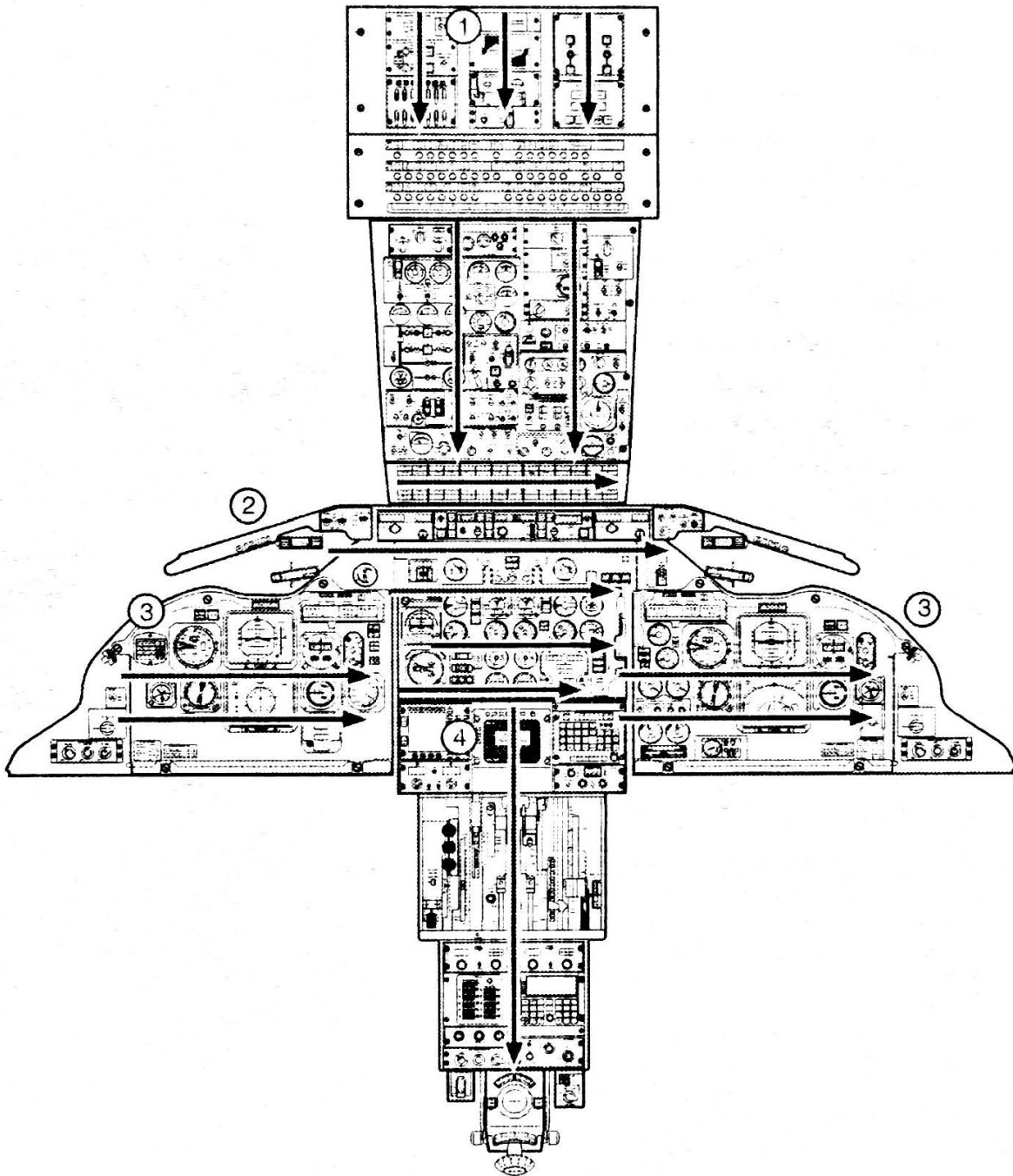

Exterior Safety Inspection

Chocks INSTALLED

Terminal – Transit Service, the Left MLG should have fore and aft chocks. Terminal – Overnight, the Left and Right MLG should have fore and aft chocks.

Flight Control Surface Areas CLEAR

APU Exhaust Area CLEAR

Landing Gear Doors / Bypass Handle CHECK

Check that MLG Bypass Handle (right side) is in agreement with main landing gear doors.

CAUTION

With the Bypass Handle stowed, flush with the fairing, the main landing gear doors should be in the up, closed, position. If not, do not apply hydraulic pressure and contact Maintenance.

Cockpit Preparation

Cockpit Safety Inspection

- Log Book REVIEW
- Required Manuals..... CHECK on BOARD
Refer to FM Part I, Section 3 for required manuals.
- BATT Switch..... ON (locked)
Refer to SYSTEMS – Electrical – Battery Check.
- Cockpit LightsAS REQUIRED
Flood lights are the only operable lights with only battery power available.
- Hydraulic Panel.....CHECK
 - TRANS PUMP Switch – OFF
 - ENG PUMP Switches – HI
 - AUX PUMP Switch – OFF
- Gear Handle DOWN
- Circuit BreakersCHECK

NOTE

Do not reset any tripped fuel pump circuit breakers.

Check all circuit breakers are in or are collared in compliance with dispatch requirements. Any pulled and collared circuit breaker must have supporting documentation. If a system has been permanently disabled, a circuit breaker collar is used and a placard applied adjacent to the breaker. If the circuit breaker is disabled temporarily, e.g., for an MEL item, a collar is used and there should be a corresponding E6 entry. Any undocumented pulled circuit breakers require maintenance action. Refer to QRH – EMER / ABNORM Preface – Resetting Circuit Breakers.

Cockpit Initial Preparation

Starting the APU is at the Captain's discretion. Normally it will be started approximately five minutes before departure. Earlier starts should be considered:

- When necessary to satisfy air conditioning or special electrical requirements.
- On critical flights and international flights to avoid delays resulting from APU start problems.

■ **If external power is available and APU start will be delayed:**

External Electrical Power..... ESTABLISH
 Refer to SYSTEMS – Electrical – To Use External Power.

■ **If APU will be started:**

Fire Warnings TEST
 Refer to SYSTEMS – Fire Protection – Fire Warning Test.

APU START
 Refer to SYSTEMS – APU.

APU PWR and EXT PWR SWITCHES
 (GROUND SERVICE ELEC PWR Panel)..... OFF

NOTE

APU PWR and EXT PWR Switches on GROUND SERVICE ELEC PWR Panel must be in OFF position prior to connecting APU or external power to main AC buses.

APU or External Electrical Power ESTABLISH

- For APU power refer to SYSTEMS – Electrical – To Use APU Power.
- For external power refer to SYSTEMS – Electrical – To Use External Power.

START PUMP Switch..... OFF

IRS Mode Selectors (if installed) NAV
 Observe ALIGN Light illuminates. Enter current position in FMS.
 Obtain gate coordinates from Jeppesen 10 - 9 page.

NOTES

- Refer to SYSTEMS – Navigation – **TWA** Inertial Reference System (IRS) Procedures.
- IRS Mode selectors must be out of the OFF position and IRSs properly aligned for PFD, ND, and the AUTOLAND system to test properly during preflight. No position boxes will display on POS INIT page of the MCDU until IRS Mode Selectors are placed to ALIGN or NAV.

- EMER LTS Switch ARM
- GALLEY Power ON
- Pneumatics ESTABLISH
 Refer to SYSTEMS – Air – Establishing Pneumatics.
- Air Conditioning (if A/C packs will be used, i.e.,
 no external pre-conditioned air) ESTABLISH
 Refer to SYSTEMS – Air – Air Conditioning on Ground, with or without
 Engines Running and Using APU Bleed Air.
- Exterior Lights AS REQUIRED
 Verify WING LDG LTS Switches are in the RET position and the NOSE
 LTS Switch is OFF. Verify POS / STROBE Switch is in BOTH, FLOOD
 LTS and WING / NACL Light Switches are set as required.
- FLAP / SLAT Handle and Indicators AGREE
 - Check FLAP / SLAT Handle and Flap Position Indicator agree and
 Slat Advisory Lights reflect slat position.
 - Check with Maintenance if not in agreement.
- ANTI-SKID ARM and TEST
 Refer to SYSTEMS – Landing Gear – Anti-Skid Test.
- Parking Brakes PARKED
 Check PARKING BRAKES ON Light illuminated and pressures are at
 top or above red band. If brakes are not parked, park brakes.
- Shoulder Harnesses CHECK
- Quick Reference Guides and Briefing Cards CHECK on BOARD
 - Maximum Altitude Capability Chart.
 - MD-80 (DC-9) Landing Speed Chart.
 - Jumpseat Briefing card and a Cabin Emergency Procedures card to
 assist in the jumpseat briefing; neither card is required nor is a
 facsimile in the Operating Manual. Make Info to Maintenance entry in
 E6 if a card is missing.
- O/W HTR Switch AS REQUIRED
 Normally, Overwing Heater Switch ARMED.
 If icy precipitation (snow, ice, frost, freezing rain, sleet, freezing fog, etc.)
 exists or is anticipated, or if the aircraft is to be de-iced, Overwing Heater
 Switch OFF.
- O/W HTR WARM / FAIL Lights AS REQUIRED
 If the O/W HTR Switch is ARMED, press to reset the WARM / FAIL
 Lights.

Cockpit Area Inspection

Cockpit Side Windows..... CHECK for CRAZING

If crazing observed, make an Info to Maintenance entry in E6, so that corrective action can be scheduled before crazing becomes unsatisfactory.

Crew Life Vests, O2 Masks and Smoke Goggles..... CHECK on BOARD

Flight Crew Oxygen Supply Cylinder..... CHECK

- Shutoff Valve – Open and safetied.
- Oxygen Pressure – Check.

PASS OXY MASK Switch NORM (guarded)

Protective Breathing Equipment (PBE) CHECK

The inspection consists of verifying the Tamper Evident Seal on the clear plastic access cover of the container and the Humidity Indicator. If the green Tamper Evident Seal is broken or if the Humidity Indicator is pink, refer to the MEL.

Cockpit Emergency Equipment..... CHECK on BOARD

The following equipment must be properly stowed and serviceable:

- Portable Halon Fire Extinguisher – Seal intact.
- Crash Ax.

Spare Bulb Kit CHECK

Walk-Around Inspection ACCOMPLISH

Final Cockpit Preparation

- Flight Deck Door Access System (first flight of the day)..... PREFLIGHT
Refer to SYSTEMS – Miscellaneous – Flight Deck Door and Flight Deck System Procedures.
- Maintenance Interphone Switch OFF
- Observer's Audio Control Panel SET
 - Microphone Selectors – All out.
 - Volume Controls – All off.
- Observer's Oxygen Regulator SET
 - Emergency / Normal / Test Mask Control – NORMAL (pin installed).
 - Diluter Demand Control – 100% OXYGEN.
 - Supply Toggle – OFF.
- Flight Recorder TEST / NORM
 - FLT RCDR Switch – GND TEST.
 - Check that FLT RECORDER OFF Light extinguishes.
 - FLT RCDR Switch – NORM.
- FD CMD Selector..... NORM
- CADC Selector NORM
- VERT GYRO Selector (except 96xx airplanes) NORM
- AUX GYRO INOP Light (except 96xx airplanes) EXTINGUISHED
- EFIS, COMPASS, RADIO NAV and
FMS Selectors (as installed) NORM
- Cockpit Voice Recorder TEST
 - Press TEST Button and hold for at least five seconds. The needle will not move until all channels are tested. Once the channel test is complete, the needle will deflect into the green band and remain there until the switch is released.
 - In 96xx airplanes, press the TEST Button for at least one second. STATUS Light will illuminate for one second indicating successful test.
- Electrical System CHECK
Refer to SYSTEMS – Electrical – Electrical System Pre-Flight.
- Emergency Power CHECK and OFF
Refer to SYSTEMS – Electrical – Emergency Power Check.
- Main Tank Fuel Pumps..... OFF
Pump being used for APU operation should remain on.
- Center Tank Fuel Pumps (if center tank fuel
available and required for flight)..... CHECK
Refer to SYSTEMS – Fuel – Center Tank Fuel Pumps Check.

- L and R ENG START Switches..... OFF (guarded)
- ENG IGN Selector OFF
- L and R FUEL HEAT Switches..... OFF
- NO SMOK Switch..... OFF
 The No Smoking Switch will have a deactivated placard installed and the switch remains in the OFF position. The No Smoking Signs in the cabin have been deactivated and No Smoking placards installed.
- SEAT BELTS Switch OFF
- Probe Heat CHECK and CAPT
 METER SEL & HEAT Switch – Check for HEATER CUR Meter indications in all positions except RAT PROBE and that the PITOT / STALL HEATER OFF Light remains extinguished.
- AIR FOIL ANTI-ICE Switches..... OFF
- WINDSHIELD ANTI-FOG Switch..... OFF
- WINDSHIELD ANTI-ICE Switch..... ON or A-ICE

NOTE

When windshields have been cold soaked, they may require up to 30 minutes to warm up thoroughly.

- ENG ANTI-ICE Switches..... OFF
- EFIS Selector (if installed)..... BOTH ON 1 / BOTH ON 2 / NORM
 - Check EFI 1 (EFI 2 when in BOTH ON 2) legend appears on Captain's and First Officer's PFD display.
 - Check symbol generator STATUS legend appears on Captain's and First Officer's ND display when EFIS Selector is out of NORM.
 - Return switch to NORM, when check complete.
- ENG SYNC Selector OFF
- Ground Proximity Warning System TEST and NORM
 Refer to SYSTEMS – Warning & Alert – Ground Proximity Warning System.
- Cargo Smoke Detection and Fire Suppression System..... TEST
 Refer to SYSTEMS – Fire – Cargo Smoke Detection and Fire Suppression System.
- CKT BKR LT Switch AS REQUIRED
- STBY COMP LT Switch AS REQUIRED
- CKPT FLOOD LIGHTS Switch..... AS REQUIRED
- THNDRSTRM LT Switch..... OFF
- OVHD CONSOLE LTS..... AS REQUIRED
- Stall Warning System TEST
 Refer to SYSTEMS – Flight Controls – Stall Warning Test.
- MAX SPD WARN TEST
 Refer to SYSTEMS – Flight Controls – Maximum Speed Warning Test.

- MACH TRIM COMP Switch NORM
Check MACH TRIM INOP Light is extinguished and MACH TRIM COMPENSATOR Indicator on the First Officer's control column is retracted.
- YAW DAMP Switch ON
Check YAW DAMP OFF Light is extinguished.
- Air Conditioning CHECK
Check compartment temperatures and adjust as necessary.
- RADIO RACK Switch FAN
- Pressurization System SET
Refer to SYSTEMS – Air – Pressurization Pre-Flight.
- WINDSHIELD WIPER Switch(es) OFF
Check wipers are parked.
- ANNUN / DIGITAL LTS Switch TEST
- Autoland Pre-Flight Test ACCOMPLISH
Refer to SYSTEMS – Autoflight – Autoland Pre-Flight Test.
- Captain's STATIC AIR Selector NORM
- Captain's Flight Instruments CHECK
Check gyros erect and no unwanted instrument flags.
Refer to SYSTEMS – Flight Instruments – Instrument Tolerances.
- Captain's EFIS TEST
Refer to SYSTEMS – Flight Instruments – EFIS Test
- Captain's MAG / TRUE Switch (if installed) MAG
- O/W HTR WARM / FAIL Lights AS REQUIRED
If the O/W HTR Switch is ARMED, press to reset the WARM / FAIL Lights.
- Oil Quantities CHECK
For minimum oil quantity for Dispatch, refer to LIMITATIONS – Engines – Oil Quantity.
- Fire Warnings (if not previously accomplished) TEST
Refer to SYSTEMS – Fire Protection – Fire Warning Test.
- L and R ENG REVERSE THRUST Lights EXTINGUISHED
- L and R ENG REVERSE UNLOCK Lights EXTINGUISHED

CAUTION

If lights are not extinguished check with Maintenance prior to moving Reverse Levers or applying hydraulic power.

- Engine Instruments CHECK
Check that engine instruments read normal.
- Thrust Rating System TEST
Refer to SYSTEMS – Engines – Thrust Rating System Check.
- Fuel Quantity TEST
Refer to SYSTEMS – Fuel – Fuel Quantity Test.

- Fuel Panel, Quantity and Distribution
(after fueling complete)..... SET and CHECK
- If Dispatch Release is available, check that total fuel required is on board and distributed properly.
 - The allowable difference between actual gallons added (from the fuel meter reading) and that need to be added is indicated on the fuel slip. If this difference is exceeded, notify Maintenance.

NOTES

- On Weight Restricted flights, use ACARS MISC 53 to send actual fuel on board as soon as possible after fueling.
- Restricted flights are identified by a message at the top of the Departure Plan. Reporting fuel on board early will enable Load Agent to ensure weights remain within limits and help maximize payload.

- FUEL USED RESET Switch.....RESET
- SAT / TAS Indicator (if installed)NO FLAGS
- First Officer's Flight Instruments..... CHECK
Check gyros erect and no unwanted instrument flags. Refer to SYSTEMS – Flight Instruments – Instrument Tolerances.
- First Officer's EFISTEST
Refer to SYSTEMS – Flight Instruments – EFIS Test.
- First Officer's Mag / True Switch (if installed).....MAG
- Hydraulic System CHECK
Refer to SYSTEMS – Hydraulics – Hydraulic System Check.
- Brake TemperatureTEST
Brake Temperature Test Button – Press.
Check Brake Temp Gage reads in test band and OVHT Light illuminates.
- First Officer's STATIC AIR Selector NORM
- GFMS (if installed).....ACCOMPLISH PRE-DEPARTURE PROCEDURES
Refer to SYSTEMS – GFMS Operation – Pre-Departure Procedures.
- FMS (if installed)ACCOMPLISH PRE-DEPARTURE PROCEDURES
Refer to SYSTEMS – FMS Operation – Pre-Departure Procedures.
- Radar TEST and OFF
Refer to SYSTEMS – Warning & Alert - Weather Radar.
- VHF-3 Control Panel (if installed) –
VOICE / DATA Button (96xx airplanes).....VERIFY in DATA MODE

NOTE

DATA MODE can be verified by VOICE COMM mode not annunciated on ACARS AOC INDEX page. Refer to SYSTEMS – Communications – **TWA** ACARS OPERATIONS

- ACARS DATA / SET
Accomplish Pre-Flight procedures through Loading Flight Information.
Refer to SYSTEMS – Communications – ACARS Operation.
- TCAS / Transponder TEST / STBY
Refer to SYSTEMS – Warning & Alert – TCAS.
- Stabilizer Trim CHECK
Refer to SYSTEMS – Flight Controls – Stabilizer Trim Check.
- SPD BRK / SPOILER Lever RET
- RUD HYD CONT Lever PWR
If right hydraulic system is pressurized, rapid and sudden movement of
Rudder Pedals can occur when switching from MAN to PWR.
- Thrust Reverse Levers DOWN
- Throttles CHECK TRAVEL and AURAL WARN
Refer to SYSTEMS – Engines – Throttle Travel and Aural Warn Check.
- FUEL X FEED Lever OFF
- FUEL Levers OFF
- PMS ACCOMPLISH PRE-FLIGHT PROCEDURES
Refer to SYSTEMS – FMS – Performance Management System.
- STABILIZER TRIM Switch NORM (guarded)
- AHRS Compass Controllers (if installed) SLAVED

NOTE

Compass Controller Switches should be in SLAVED for flight. Heading Deviation Indicators should be centered, except local magnetic interference (jet bridge, fuel truck) may cause deflection and / or heading comparator lights to illuminate until after gate departure.

- AILERON and RUDDER TRIM CHECK and ZERO
Check travel a small amount in each direction, then set zero on Trim Indicators.
- AUTO BRAKE (if installed) DISARM and OFF

NOTE

On all ferry and functional check flights without Flight Attendants on board, check all galley drawers and doors are closed and latched prior to taxi.

Walk-Around Inspection

General

Recommended sequence is to start at the left forward fuselage and walk around entire airplane in a clockwise direction.

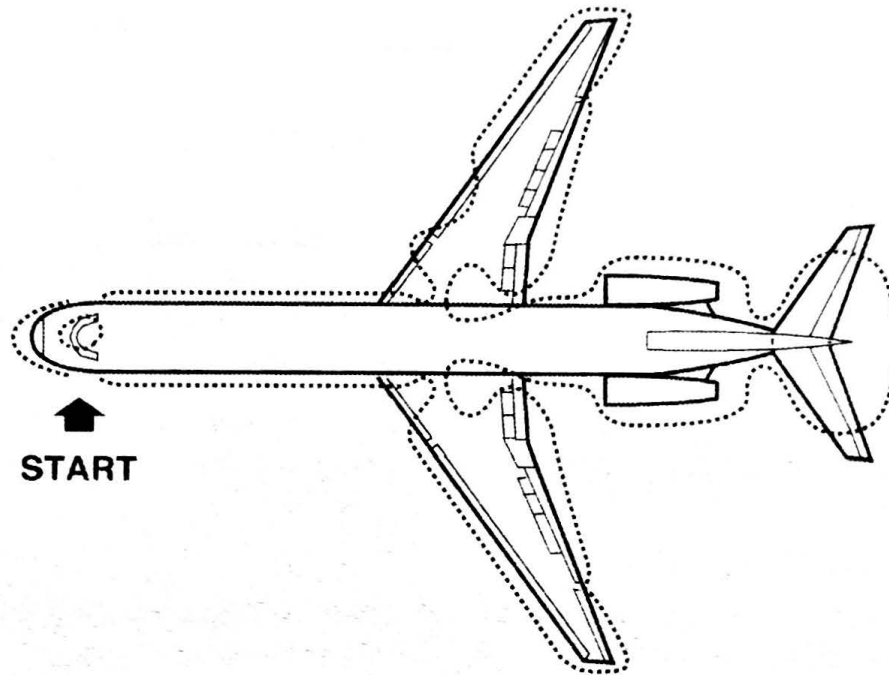

CAUTION

Airplanes that are exposed to high-sustained winds, or wind gusts, greater than 75 MPH (approximately 65 knots) are susceptible to elevator damage and / or jamming. In accordance with the Aircraft Maintenance Manual, airplanes suspected to have been exposed to these conditions must have visual and physical inspections (moving the surfaces by hand) of all flight controls and an operational check of these systems.

During walk-around, make the following general checks:

Surfaces and Structures

Undamaged (pay particular attention to cargo doors and airplane skin areas adjacent to the cargo doors), no missing parts, windows, no fluid leakage, structural integrity, flight control surfaces clear.

NOTE

Having an operative Overwing Heater System does not relieve the flight crew of the requirement to check that the airplane surfaces must be free of frost, snow, and ice accumulation, as required by Federal Aviation Regulations (FARs) Section 91.527 and 121.629.

Ground Lock Pins

If a landing gear ground lock pin is found installed, station personnel (maintenance and / or agent) must be notified that the pin needs to be removed before departure. Prior to departing the gate, a crewmember will visually check the gear to confirm that the pin has been removed.

If the pin belongs to the airplane, it should be returned to the airplane.

NOTE

Crewmembers will not remove gear ground lock pins. Removal of all gear pins is the sole responsibility of the station.

Tires and Wheels

Check tires are properly inflated (check fill valve gage). Also check tires for excessive wear, cuts, bulges, bruises, tread separation, recap damage, imbedded foreign objects, etc. Check wheels for damage.

Brakes

If the brakes are released at the time the exterior walk-around is being made, the brake wear check will need to be postponed until after the brakes are parked.

Wheelwell Area

Check wheel wells for tools, loose or damaged parts, no fluid leakage, and foreign objects that could obstruct clearance during retraction.

Clearance between landing gear structures, lines, hoses, etc., and tires should be examined to be sure that no parts of the gear are rubbing against the tires.

Engines and Cowlings

Unobstructed inlets and exits, no internal or external damage, reversers stowed, access panels and cowlings secured, no fluid leakage. Fan blades undamaged.

Doors

If not in use, visibly secure and handles recessed.

Access Panels

Secured and latches locked. No fluid leakage, especially around the potable water and lavatory fill / drain areas.

Report leakage or evidence of leakage to Maintenance for corrective action as determined by maintenance procedures.

NOTE

If any evidence of fluid leakage or stains is noted at the forward and / or aft lavatory service panel, ground personnel must verify if a leak exists before departure. If a leak is present, repairs must be made or the affected lavatory must be drained and placarded inoperative.

Probes

Uncovered, undamaged, clean and unobstructed.

Static Ports

Clean and unobstructed.

CAUTION

Careful inspection of static ports is particularly important whenever airplane has landed with dry snow on the runway. Reverse exhaust directed forward picks up and melts snow which refreezes on contact with surfaces as clear ice film which is difficult to detect visually.

Antennas

Undamaged.

Lights

Lenses clean, secure, undamaged, no evidence of overheat and illumination if required.

NOTE

Minimize use of exterior lights to prevent extreme heat build up.

Inspection

Check the following items on the walk-around:

Left Forward Fuselage

- Stall warning vane
- Strake
- WHEEL WELL LIGHTS Switch – ON

Nose Section

- Pitot probes
- Windshield wipers – Parked
- Radome
- Windshields

Nose Gear and Wheel Well

- Tires and wheels
If fill valve gage installed, check for normal tire inflation range: 160 – 170 psi. On thru flight inspections, higher readings may be observed due to heat build-up.
- Shock strut inner cylinder visible and no leaks
- Steering linkage connected
- Taxi and nose gear landing lights
- Wheel well area
- Ground lock pin removed
- Nose gear ground sensing mechanism connected
- Spray deflector

■ **If metal deflector installed:**

- Check flexible deflector side plate is attached to deflector.
- Check aft center deflector undamaged.

■ **If polyurethane deflector installed:**

- Check flexible deflector side plate is attached to deflector.
- Check debris deflectors properly attached and undamaged, if installed.
- Check aft center deflector undamaged.
- Electronic compartment access door

Right Forward Fuselage

- Stall warning vane
- Ram air temp probe
- Strake
- Oxygen blowout disc intact
- Static ports
- Ground and wing leading edge floodlights
- Antennas

Right Wing

- Visually check upper and lower wing surface including the area behind the Overwing Heater Assembly for clear ice / frost.

CAUTIONS

- *As upper wing ice begins to melt, it may slide back toward the aft portion of the wing behind the area where it originally formed.*
- *If the Overwing Heater System was on during or after the airplane had been exposed to snow, ice or freezing rain for a long period of time, there is a possibility that the precip could melt and refreeze on the lower wing surface and in the flap well behind the rear spar. If icicles (see graphic) are observed on the lower wing surface, the flaps must be lowered after deicing, to check for ice in the flap wells. (Refer to GENERAL – Upper Wing Clear Ice / Frost for procedure to follow if this condition is observed.)*

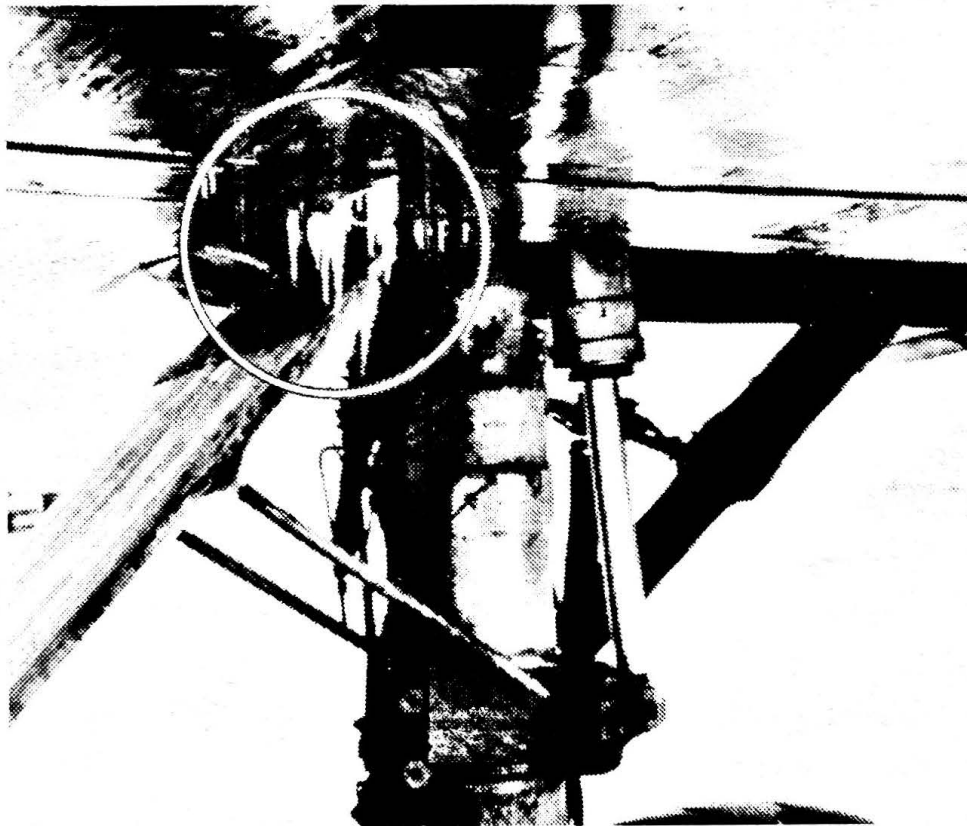

- Inboard wing undersurface and leading edge slats aligned, undamaged and no leaks
- Outboard wing undersurface and leading edge slats aligned, undamaged and no leaks
- Wing landing and position lights

NOTE

Strobe lights cannot be checked on the ground.

- Static dissipators in place
- Aileron and flaps

Right Gear

- MLG Door Hydraulic Bypass Handle (right side only) in agreement with main landing gear doors

CAUTION

With the Bypass Handle stowed, flush with the fairing, the main landing gear doors should be in the up, closed, position. If not, do not apply hydraulic pressure and contact Maintenance.

- Tires and wheels

If fill valve gage installed, check for normal tire inflation range: 190 – 200 psi. On thru flight inspections, higher readings may be observed due to heat build-up.

- Brake wear indicators (if brakes parked)

NOTES

- Maintenance requests that they be notified before Brake Wear Indicator Pins go below limits. Maintenance will determine if brake assembly requires replacement.
- The MLG brakes have two wear indicator pins. If one is missing, the brake may remain in service provided the remaining pin indicates that brake wear is within limits.
- If both Brake Wear Indicators are missing, Maintenance has an alternate method to determine brake wear.
- Debris deflector
- Shock strut inner cylinder visible and no leaks
- Spoiler Depressurization Valve – SPOILER ON (and safetied)
- Wheel well area
- MLG position inspection lights (spotlights)
- Ground lock pin removed

Right Aft Fuselage

- Overwing exits (2) flush
- Pt2 probe and inlet bullet
- Engine cowling, thrust reverser, fasteners, and nacelle strake
- Empennage and Control Surfaces
- Static dissipators in place

Stabilizer, elevators and rudder

- Tailcone securely latched
- Tail Bumper and Compression Indicator – Horizontal

Left Aft Fuselage

Inspection same as right aft fuselage

Additionally:

- Tailcone Exterior Jettison Handle – Flush
- Aft Lav Service Panel – Checked
- Outflow valve complex:
 - Outflow Butterfly Valve – Open
 - Outflow Nozzle – Open

Left Gear

Inspection same as right gear

Left Wing

Inspection same as right wing

Left Forward Fuselage

Inspection same as right forward fuselage

Additionally:

- Potable Water Service Panel – Checked
- Cabin Pressure Relief Valves – Flush
- Fwd Lav Service Panel – Checked
- WHEEL WELL LIGHTS Switch – OFF

Cockpit Clean-up Inspection

- Walk-Around Inspection..... COMPLETED
- Log Book and Flight Forms..... CHECK on BOARD /
REVIEWED / ACFT NO. ____
- Check E6 Log Book and Flight Forms (Flight Plan / Release and TPS)
 are on board, reviewed and agree with the airplane tail number.
- Protective Breathing Equipment (PBE)..... CHECK
- Shoulder Harnesses CHECK
- Flight Crew Oxygen Supply Cylinder..... CHECK
 - Shutoff Valve – Open and safetied
 - Oxygen Pressure – Check
- Circuit Breakers CHECK
 - Check all circuit breakers are in unless pulled and collared.
- BATT Switch ON (locked)
 - Refer to SYSTEMS – Electrical – Battery Check.
- EMER PWR Selector..... OFF
- APU PWR and EXT PWR
Switches (Ground Service ELEC PWR Panel) OFF

NOTE

APU PWR and EXT PWR Switches on Ground Service ELEC PWR Panel must be OFF prior to connecting APU or external power to main AC buses.

- APU (as required)..... START / ESTABLISH POWER
 - Refer to SYSTEMS – APU – APU Start – Ground / In Flight and
SYSTEMS – Electrical – To Use APU Power.

APU start is at the Captain's discretion. Normally it will be started approximately five minutes before departure. Consider earlier starts:

- When necessary to satisfy air conditioning or special electrical requirements.
- On critical flights and international flights to avoid delays resulting from APU start problems.

Defer use of APU power as long as external power is connected.

- START PUMP Switch..... OFF
- EMER LTS Switch ARM
- GALLEY Power ON
- Flight Recorder..... TEST / NORM
 - FLT RCDR Switch – GND TEST
 - Check FLT RECORDER OFF Light extinguishes.
 - FLT RCDR Switch – NORM

IRS Mode Selectors (if installed) VERIFY NAV

NOTES

- Refer to SYSTEMS – Navigation – **TWA** Inertial Reference System (IRS) Procedures
- IRS Mode Selectors must be out of the OFF position and IRSs properly aligned for PFD, ND, and the AUTOLAND system to test properly during preflight. No position boxes will display on POS INIT page of the MCDU until IRS Mode Selectors are placed to ALIGN or NAV.
- To perform an ALIGN Downmode (Quick Align), refer to SYSTEMS – Navigation – Inertial Reference System (IRS) Procedures.

Center Tank Fuel Pumps (if center tank fuel available and required for flight) CHECK
Refer to SYSTEMS – Fuel – Center Tank Pumps Check.

Probe Heat CHECK and CAPT
METER SEL & HEAT Switch – Check for HEATER CUR Meter indications in all positions except RAT PROBE and that PITOT / STALL HEATER OFF Light remains extinguished.

WINDSHIELD ANTI-ICE Switch ON or A-ICE
YAW DAMP Switch ON
Check YAW DAMP OFF Light is extinguished.

Pneumatics ESTABLISH(ED)
Refer to SYSTEMS – Air – Establishing Pneumatics.

Air Conditioning (if A/C packs will be used, i.e., no external pre-conditioned air) ESTABLISH(ED)
Refer to SYSTEMS – Air Conditioning on Ground, with or without Engines Running and Using APU Bleed Air.

Pressurization System SET
Refer to SYSTEMS – Air – Pressurization Pre-Flight.

Exterior Lights AS REQUIRED

Autoland Pre-Flight Test (if required) ACCOMPLISH
Refer to SYSTEMS – Autoflight – Autoland Pre-Flight Test.

- O/W HTR WARM / FAIL Lights.....AS REQUIRED
If O/W HTR Switch is ARMED, press to reset the WARM / FAIL Lights.
- Oil Quantities CHECK
For minimum oil quantity for Dispatch, refer to LIMITATIONS – Engines – Oil Quantity.
- Engine Instruments..... CHECK
Check that engine instruments read normal.
- Fuel Panel, Quantity and Distribution
(after fueling complete) SET and CHECK
 - If Dispatch Release is available, check that total fuel required is on board and distributed properly.
 - The allowable difference between actual gallons added (from the fuel meter reading) and that need to be added is indicated on the fuel slip. If this difference is exceeded, notify Maintenance.

NOTES

- On Weight Restricted flights, use ACARS MISC 53 to send actual fuel on board as soon as possible after fueling.
- Restricted flights are identified by a message at the top of the Departure Plan. Reporting fuel on board early will enable Load Agent to ensure weights remain within limits and help maximize payload.

- FUEL USED RESET Switch..... RESET
- GEAR Handle and Lights..... DOWN, THREE GREEN
- FLAP / SLAT Handle and Indicators..... AGREE
Check that the FLAP / SLAT Handle and Flap Position Indicator agree and that Slat Advisory Lights reflect slat position.
Check with Maintenance if not in agreement.
- Hydraulic Quantities..... CHECK
Refer to SYSTEMS – Hydraulics – Hydraulic System Check.
- Thrust Reverser Levers DOWN
- Throttles..... CHECK TRAVEL and AURAL WARN
Refer to SYSTEMS – Engines – Throttle Travel and Aural Warn Check.

GFMS (if installed)..... ACCOMPLISH PRE-DEPARTURE PROCEDURES
Refer to SYSTEMS – GFMS Operation – Pre-Departure Procedures.

FMS (if installed) ACCOMPLISH PRE-DEPARTURE PROCEDURES
Refer to SYSTEMS – FMS Operation – Pre-Departure Procedures.

ACARS DATA / SET
Accomplish Pre-Flight procedures through Loading Flight Information.
Refer to SYSTEMS – Communications – ACARS Operation.

TCAS / Transponder TEST / STBY
Refer to SYSTEMS – Warning & Alert – TCAS.

PMS ACCOMPLISH PRE-FLIGHT PROCEDURES
Refer to SYSTEMS – FMS – Performance Management System (PMS).

NOTE

On all ferry and functional check flights without Flight Attendants on board, determine that all galley drawers and doors are closed and latched prior to taxi.

Table of Contents

Before Starting Engines

Preface 10.1

Expanded Checklist 10.1

Considerations Prior to Departure 10.7

Use of Aft Stairs for Passenger Enplaning 10.7

Route / Legs Verification on GFMS / FMS 10.8

Verify Flight Plan 10.8

Legs Verification Check 10.8

PROG Verification Check 10.8

Takeoff Briefing 10.9

Takeoff Briefing Example (Captain) 10.9

Starting Engines

Engine Start Sequence 15.1

During or after Pushback Start 15.1

Gate Start 15.1

Cockpit to Ground Communications 15.1

Starting at the Gate and Taxi-Away 15.2

Starting during Pushback 15.3

Starting after Pushback 15.4

Starting at the Gate, Then Pushback 15.4

Accommodating "Last Minute" Baggage after Engine Start 15.5

Forward and Mid Cargo Compartments 15.5

Aft Cargo Compartment 15.5

Accommodating "Last Minute" Passengers after Engine Start 15.5

Starting Engines Procedure 15.6

Powerback from Gate 15.11

Powerback Procedures 15.11

Powerback Signals 15.12

Initiation of Powerback 15.12

Powerback in a Turn 15.13

Termination of Powerback 15.13

Ramp Departure 15.14

Special Cautions 15.14

Restrictions 15.14

Before Starting Engines

Preface

The items on the Before Starting Engines checklist will have been and / or will be accomplished by the appropriate crewmember as indicated by the duty assignment column.

This checklist is accomplished by challenge and response. The First Officer will read the challenge portion. The Captain will respond aloud to all items ensuring accomplishment of all checks and items. The First Officer will also respond aloud to those items identified by a ‡. When all items have been accomplished the First Officer will advise – *"Before Starting Engines checklist complete."*

Any functional check or test included in this checklist (such as O2 Masks, NAV Radios, etc.) need not be repeated if a crewmember confirms having previously completed such check or test.

If accomplishment of the checklist is interrupted due to a crewmember leaving the cockpit and, during the crewmember's absence, there has been a non-crewmember in the cockpit, who may have inadvertently moved a switch, control, etc., the checklist shall be re-accomplished in its entirety.

Expanded Checklist

Captain	First Officer
WARM LIGHTAS REQUIRED If WARM Light fails to illuminate with the O/W Heater Switch ARMED prior to gate departure, refer to MEL.	
RUDDER PEDALS and SEATSADJUSTED and LOCKED ‡ Check that seat is adjusted and properly locked in the forward and aft tracks and that rudder pedals are properly adjusted for seat position.	
WINDOWS..... CLOSED and LOCKED ‡	
O2 MASKS / REGULATORS / INTERPHONE / GOGGLES / O2 PRESSURE..... SET and CHECKED ‡ Refer to SYSTEMS – Miscellaneous – Oxygen – Cockpit Oxygen System.	
IRS PANEL (if installed)NAV / LTS OUT Verify no Basic ATT or IRS ATT MODE Light annunciation on the EOAP.	
AHRS COMPASS CONTROLLERS (if installed)..... SLAVED	
EMERGENCY LIGHTSARMED	
PROBE HEAT CAPT	



**WINDSHIELD ANTI-ICE..... ON or A-ICE**

A "hand-feel" check of the three windshields is used to verify operation of the windshield anti-ice system. ANTI-FOG Switch must be in OFF position while accomplishing this check.

PRESSURIZATIONAUTO (up) and SET

- LDG ALT – Departure Field Elevation
- LDG BARO – Current Altimeter Setting (MSL)
- RATE LIMIT Knob – Set at Index Mark

FLIGHT GUIDANCE PANEL..... SET and CHECKED

- NAV Frequencies – As desired
- CRS Select Knobs – Set
- FD Switches – FD
- Autothrottle System – Set / OFF
 - SPD / MACH Select Knob – Set
Set cruise Mach in Mach Readout and 250 in Speed Readout
 - AUTO THROT Switch – OFF
- HDG Select Knob – Set
 - Bank Angle Limit – As required (normally 15°)
 - Heading – As desired
- Pitch Control Wheel – Set to zero
- AP ON Switch – OFF
- DFGC 1-2 Switch – As required
- Altitude – As desired
- Flight Mode Annunciators Legend Lights – Extinguished



**FLT INSTR / SWITCHES / BUGS.....SET and CROSSCHECKED ‡**

Both pilots will check their respective instruments, switches, or bugs, verifying each item is correct.

- CADC and EFIS Selectors – NORM
- VERT GYRO and FD CMD Selectors – As required
- COMPASS and RADIO NAV Selectors (if installed) – NORM
- STATIC AIR Selector – NORM
- Clocks – Set
- Mach / Airspeed Indicators – Check and set
 - IAS – Zero
 - Mach – .150
 - Set Airspeed References to:
 - V₁
 - V₂ (orange reference bug)
 - Flap Retract 0 / EXT
 - Slat Retract 0 / RET
 - Clean Min Man Speed
 - Airspeed Command Bug set to 250 knots or as appropriate.
- Altimeters – Set and check
 - Captain's, First Officer's, and Standby Altimeter:
 - Set QNH and crosscheck all altitude indications.
 - Altitude Reference Index (bug) – Set E/O ACCEL ALT (MSL) shown on TPS for planned departure runway.
 - Radio Altimeter indicates Zero, DH bug as desired.
- RMI's – Check
 - No flags
 - VOR / ADF Selector Knobs – As desired
 - Headings compare between RMI's, HSI's, and Standby Magnetic Compass are in general agreement with no flags.
- HSI's – No flags
- RA / VSI – Zero
- Standby Airspeed Indicator – Zero
- Standby Attitude Indicator – Check
 - Power OFF Flag retracted
 - Gyro erect
 - Airplane symbol properly positioned





- Takeoff Mode – Selected
It is AA policy to use standard thrust takeoffs where permitted.
- For Standard Thrust:**
 - Assumed Temp – Set
 - ART Switch – OFF
 - T.O. FLX – Press
- For Maximum Thrust:**
 - Assumed Temp – Zero
 - ART Switch – AUTO
 - T.O. – Press
- For Reserve Thrust:**
 - Assumed Temp – Zero
 - ART Switch – OFF
 - T.O. – Press
- EPR – Bugs set

FUEL PANEL / QUANTITY and DISTRIBUTION..... SET / ___ LBS and CHECKED

- All Tank Pump Switches – OFF
- Pump being used for APU operation should remain on.
- Gross Wt Display – Set
- Set ZFW per Load Plan.
- FUEL X FEED Lever – OFF

Fuel Quantity and Distribution – Checked

- Confirm that the total fuel required by the Dispatch Release is on board and distributed properly.
- If Fuel Slip is provided, check that actual amount added (from truck meter) is within tolerance specified on Fuel Slip. If allowable difference is exceeded, notify Maintenance.

GEAR HANDLE and LIGHTSDOWN, THREE GREEN

GFMS / FMS DATA INSERTED

- Check PDC route vs. Flight Plan
- Verify Route / Legs. Refer to Route / Legs Verification on GFMS / FMS this section.





	<p>TRANSPONDER TA / RA and SET</p> <ul style="list-style-type: none"> • Function Selector – TA / RA • Code Selector – Set <p>For Single Mode S:</p> <ul style="list-style-type: none"> • ALT Source Selector – 1 or 2 Place in agreement with DFGC 1-2 Switch. <p>For Dual Mode S:</p> <ul style="list-style-type: none"> • ATC Transponder Selector – 1 or 2 • ALT Source Selector – 1 or 2 Place in agreement with DFGC 1-2 Switch.
<p>STABILIZER TRIM.....SET</p> <ul style="list-style-type: none"> • CG Thumbwheel – Set • FLAP Thumbwheel – Set • Long Trim Indicator – Aligned with Long Trim Takeoff Position Indicator 	
<p>SPOILER LEVERRET</p>	
<p>TAKEOFF WARNINGCHECKED‡ Verifies takeoff warning system checked during preflight inspection.</p>	
<p>THROTTLESCLOSED REVERSE Levers – DOWN</p>	
<p>FUEL LEVERSOFF</p>	
<p>FLAPS / SLATS UP / RET</p> <ul style="list-style-type: none"> • Check FLAP / SLAT Handle and Indicator agree. • Check SLAT Lights are extinguished. • If Flaps / Slats are not retracted coordinate with ground personnel before moving FLAP / SLAT Handle. <ul style="list-style-type: none"> – The flap / slat system may not fully retract using only the auxiliary pump. Full retraction may require both hydraulic systems to be pressurized. 	
<p>AILERON / RUDDER TRIMZERO / ZERO</p>	
<p>PARKING BRAKE / PRESSUREPARKED / NORMAL</p> <p>Check BRAKE PRESS Gage reads above red band.</p>	



10.6 STARTING

10-17-07



F/A BRIEFING COMPLETED	
TAKEOFF BRIEFING COMPLETED	
Ten Minutes Prior to Departure	
SEAT BELT SIGNS ON Turning on FASTEN SEAT BELT Signs alerts F/A's to seat passengers and make pre-departure announcements.	
ACARS FUEL / APU HOURS UPDATED	
LOG BOOK and FLIGHT FORMS ON BOARD / REVIEWED / ACFT NO. ____ ‡ Check E6 and Flight Forms (Flight Plan / Release and TPS) are on board, reviewed and agree with airplane number.	
Prior to Engine Start or Pushback	
FUEL PUMPS ON Leave AUX TANK TRANS PUMP Switches OFF. ■ If center tank does not contain usable fuel: Leave CTR TANK PUMP Switches OFF.	
	AUX HYDRAULIC PUMP ON ANTI-COLLISION / EXTERIOR LIGHTS ON / AS REQUIRED <ul style="list-style-type: none"> • Turn on Anti-Collision lights to alert ground personnel engines are about to be started. • Position POS / STROBE Lights Switch to BOTH.





DC9 Operating Manual

BULLETIN

Subject: Revised Before Start Checklist for Electronic Flight Bag Operations

No. DC-9-113

Date 11-12-07

File: Vol. I – STARTING 10.7

General

The Before Start checklist is revised to support Electronic Flight Bag (EFB) use in the cockpit. A revision bar identifies the new item.

Checklist Procedure



DOORS	CLOSED
For any door light or switch problem, refer to MEL.	
CABIN READY REPORT	RECEIVED
Cabin ready report may be received by interphone.	
NOTE	
Do not delay engine start for powerback while waiting for Cabin Ready Report. The report is only needed prior to pushback / powerback.	
COCKPIT DOOR	CLOSED and SECURED
Verify the Flight Deck Door Power Cutoff Switch is in the NORM position (guard closed).	
NOTE	
After any power transient on the Left DC Bus the flight crew should check the security of the cockpit door by pushing and / or pulling on the door.	
EFB (if used)	OFF and STOWED
If the Electronic Flight Bag (EFB) laptop computer is being used, turn the laptop computer off / sleep / hibernate and stow the computer.	
SHOULDER HARNESSSES	ON ‡

For the DC9 Fleet Support Team
Captain R. David Johnson



<p>DOORS CLOSED</p> <p>For any door light or switch problem, refer to MEL.</p>
<p>CABIN READY REPORT RECEIVED</p> <p>Cabin ready report may be received by interphone.</p> <p style="text-align: center;">NOTE</p> <p>Do not delay engine start for powerback while waiting for Cabin Ready Report. The report is only needed prior to pushback / powerback.</p>
<p>COCKPIT DOOR..... CLOSED and SECURED</p> <p>Verify the Flight Deck Door Power Cutoff Switch is in the NORM position (guard closed).</p> <p style="text-align: center;">NOTE</p> <p>After any power transient on the Left DC Bus the flight crew should check the security of the cockpit door by pushing and / or pulling on the door.</p>
<p>SHOULDER HARNESSSES ON ‡</p>

Considerations Prior to Departure

To optimize situation awareness, the Captain should ensure that significant terrain and obstacles affecting departure are identified. Review charted MSA, Grid MORA, MEA, contour or spot elevation, EGPWS, and TRR indicated on the flight plan (highest actual terrain height 5 nm left and right of course between route waypoints on the planned route).

Both pilots should review field conditions and special procedures for departure airport, including Ops Advisory pages and planned taxi route. When the ATIS indicates that SMGCS procedures are in effect, brief the SMGCS page.

Use of Aft Stairs for Passenger Enplaning

At some stations, aft stairs may be used for passenger enplaning. After all passengers are on board, the following procedures apply when the aft stairs are used:

- Agent closes and locks aft cabin door.
- Guideman informs crew by ground interphone that boarding is complete.
- AUX HYD PUMP Switch – ON.
- Agent raises stairs and closes stair control access door.
- Crew checks doors closed before pushback or engine start.

Route / Legs Verification on GFMS / FMS

Verify Flight Plan

RTE Key PRESS

After flight plan has been activated and executed, the Captain and First Officer will check RTE page to ensure route displayed, including departure procedures (DPs), agrees with filed flight plan and ATC clearance (PDC). One pilot will read from RTE page while other pilot checks what is read against the ATC clearance, SIDs, STARs, RNAV procedures and flight plan.

Legs Verification Check

LEGS Key PRESS

Following the route verification check, the flight crew will perform the legs verification check for the complete flight plan route and note or resolve any discrepancies. If the active route is modified (e.g., change in departure, arrival or route), complete the legs verification check for that segment which has been modified. One pilot will read from the LEGS page while the other pilot verifies waypoints against SIDs, STARs, RNAV procedures and flight plan including any amended portion of the route are correct.

After satisfactory route check:

Backup copy of Flight Plan (GFMS ONLY):

RTE Key PRESS

RTE COPY [5L] PRESS

PROG Verification Check

PROG Key PRESS

Check total mileage against flight plan for reasonableness.

Route Discontinuity

A route discontinuity is created whenever there is no defined path between successive waypoints in a flight plan. Discontinuities may be created by waypoint deletion, addition, or procedure stringing.

The system does not automatically bridge discontinuities caused by inserting legs into the route. Whenever the aircraft gets to a route discontinuity, the message "DISCONTINUITY" is displayed in the scratchpad, and the aircraft will maintain its existing track.

Discontinuities can be cleared by line selecting the next waypoint after the ROUTE DISCONTINUITY into the scratchpad. The pilot then presses the Line Select Key next to the discontinuity (box prompts), followed by the EXEC Key, thus clearing the ROUTE DISCONTINUITY.

Takeoff Briefing

The briefing is completed at the gate, to the extent possible, to allow both pilots to focus on taxi operations after gate departure. Last minute clearance changes from ATC (taxi or departure) will be verbalized by the F/O and verified by the Captain. Checklist items covering the departure procedure need not be briefed unless some contingency or exception exists. When required, the Captain will conduct whatever briefing is appropriate to the situation (e.g., poor weather, inexperienced crew member, etc.). The Captain, at his / her discretion, may delegate the briefing to the F/O (Pilot-Flying), with the understanding the Captain will take the aircraft in the event of an RTO in compliance with current policy.

The takeoff briefing will be conducted by the Captain (or at the Captain's discretion, the Pilot-Flying) **at the gate** and include, as a minimum:

- Designate the pilot-flying
- Rejected takeoff considerations.

Contingencies, if appropriate:

- Departure procedure (required only if not covered previously by checklist completion or if revised by ATC)
- Airport specific engine failure profile
- Takeoff alternate
- Takeoff weather considerations
- Runway surface conditions
- Terrain considerations
- Any other variables associated with the taxi and takeoff.

Takeoff Briefing Example (Captain)

A takeoff briefing for a DFW departure could be:

"You are the pilot flying."

"For an abort, I will take the aircraft and comply with the abort procedure."

And, if applicable:

"We are cleared for the Dallas 7 departure, Corona transition with a revised heading of 200° to 10,000 ft."

"The runway is wet and we have a takeoff alternate of Little Rock."

Starting Engines

Engine Start Sequence

During or after Pushback Start

Start left engine during pushback, followed by right engine after brakes are parked at the completion of pushback. However, when not prohibited, the Captain may elect to taxi away from the gate / ramp area with right engine shut down.

Gate Start

Normal gate start sequence is left engine then right engine. However, when not prohibited, the Captain may elect to taxi away from the gate / ramp area with the right engine shut down. In this case, only the left engine is started.

The left engine may be started if Aft Service Door is closed and Forward Entry Door is closed or protected by a passenger loading bridge. Right engine may be started if the aft cargo door is closed.

If ground electrical power or ground air is used, it will be removed only on specific request from the cockpit.

Cockpit to Ground Communications

Communication between Captain and Guideman is as follows:

- Five minutes prior to departure, Guideman will initiate ground to cockpit communication and request – “*Parking brake parked.*” Captain will respond – “*Parking brake parked.*”
- All communications between Captain and Guideman will be by interphone (see Flight Manual Part I for exceptions) except when Guideman gives departure salute. Hand signals may be used if interphone or guideman’s headset is inoperative or at Captain’s discretion. All Captain’s audio panel Volume Control Levers, except INT, should be OFF during engine start and / or pushback.
- Pushback and / or starting engines will be accomplished with the aid of a Guideman. Do not start any engine until communication is established and proper start signal received from Guideman.

CAUTION

If the towbar breaks or the airplane becomes disconnected from the tug during pushback, the Guideman will advise the Captain “Brakes.” This call indicates the Captain must stop the airplane using the airplane’s brakes.

NOTE

If the towbar breaks or becomes disconnected from the airplane, the airplane must be inspected by Maintenance prior to continuing operations. The airplane is not required to return to the gate for this inspection. If no damage is found, pushback operations may be continued using a new towbar, however, the crew must make an E6 logbook "Info to Maintenance" entry stating:

"Towbar broke and / or disconnected during pushback. Inspection accomplished with no damage noted by Mechanic (insert Mechanic's name and employee number or certificate number if non-AA employee)."

Maintenance will make a balancing entry at a down-line AA station.

Starting at the Gate and Taxi-Away

- Guideman will advise Captain – *"All secure below, cleared to start engines."* This indicates lower compartment doors closed, chocks are removed, loading bridge retracted and / or plane mates clear.
- When ready to start engines (and having obtained engine start clearance where required), Captain will check all Door Annunciator Lights extinguished and acknowledge – *"Parking brake parked, starting engines."*
- Captain will advise the Guideman when to disconnect the external power and / or ground air supply if used.
- When deemed appropriate and at Captain's discretion, the Captain will advise Guideman – *"Cleared to disconnect interphone."*
- Guideman will state – *"Area being cleared, disconnecting interphone."* Captain will acknowledge so that Guideman will know he / she was heard. Guideman will then disconnect interphone and assume a position in front of and slightly to the left of the airplane nose as viewed from the cockpit.

NOTE

If requested to start engines while final passengers are being boarded and / or bags are being loaded, do not advise guideman to disconnect interphone until the all secure below is given.

- Captain will flash the nose lights once when he is ready to taxi. Guideman will visually clear the area and give departure salute indicating to the Captain he / she is clear to taxi. Captain will flash the nose lights three times if necessary to recall Guideman to interphone.

Starting during Pushback

When ramp conditions are such that control of an airplane with an engine running during pushback is questionable due to contamination, e.g., snow, ice, and glycol, the following procedures will be used:

Prior to engine start, the airplane will be pushed / towed to the start position, brakes parked, tractor and tow bar disconnected and clear of the airplane.

The Ramp Manager on Duty will be responsible for making the determination of when ramp conditions are such that normal engine start cannot be accomplished during the pushback process. However, any time the Captain determines that the ramp condition requires engine start be delayed until the termination of pushback, his decision shall be final.

NOTE

If the APU is inoperative when these ramp conditions exist, one engine must be started prior to pushback to provide airplane electrical power. It shall be station responsibility to provide required sanding, etc., to ensure adequate control during pushback.

- Guideman will advise Captain, – *"All secure below, cockpit steering disabled, standing by for brake release."* This verifies tractor brakes are on, chocks are removed, loading bridge is retracted and / or plane mates clear, and the ramp area is clear.
- When ready to pushback (having obtained start / pushback clearance where required), the Captain will check Door Warning Lights extinguished and advise Guideman – *"Parking brake released, cleared to push."*
- During pushback, Guideman will advise – *"Cleared to start engines"* and Captain will respond – *"Starting engines."*
- At end of pushback, Guideman will advise – *"Parking brake parked,"* and the Captain will respond – *"Parking brake parked, cleared to disconnect interphone."* When the Guideman hears "Parking brake parked" from the Captain, that is considered clearance to disconnect the towbar. If the towbar is not to be disconnected, e.g., the pushback needs to be continued, the Captain will reply with *"Standby"*, followed by further guidance as required.
- Guideman will state – *"Area being cleared, disconnecting interphone."* Captain will acknowledge the Guideman. Guideman will proceed to specified departure salute area and wait.
- Captain will flash the nose lights once when ready to taxi. Guideman will visually clear the area and give departure salute and display the steering bypass pin indicating to the Captain that the bypass pin is removed and airplane is clear to taxi. Captain will flash the nose lights three times if necessary to recall Guideman to interphone.

Starting after Pushback

- Guideman will advise Captain, – *"All secure below, cockpit steering disabled, standing by for brake release."* This verifies the tractor brakes are on, chocks are removed, loading bridge is retracted and / or plane mates clear, and the ramp area is clear.
- When ready to pushback (having obtained start / pushback clearance where required), the Captain will check Door Annunciator Lights extinguished and acknowledge with – *"Parking brake released, cleared to push."*
- At end of pushback, Guideman will advise – *"Parking brake parked, cleared to start engines,"* and the Captain will respond – *"Parking brake parked, starting engines, cleared to disconnect interphone."* When the Guideman hears "Parking brake parked" from the Captain, that is considered clearance to disconnect the towbar. If the towbar is not to be disconnected, e.g., the pushback needs to be continued, the Captain will reply with *"Standby"*, followed by further guidance as required.
- Guideman will state – *"Area being cleared, disconnecting interphone."* The Captain will acknowledge and Guideman will proceed to specified departure salute area and wait.
- Captain will flash the nose lights once when ready to taxi. Guideman will visually clear the area, give departure salute, and display the steering bypass pin indicating the bypass pin is removed and airplane is clear to taxi. Captain will flash the nose lights three times if necessary to recall Guideman to interphone.

Starting at the Gate, Then Pushback

- Guideman will advise Captain – *"Cleared to start engines."*
- When ready to start engines (and having obtained engine start/pushback clearance where required), Captain will acknowledge – *"Parking brake parked, starting engines."*
- Captain will advise the Guideman when to disconnect the external power and / or ground air supply if used.
- Guideman will advise Captain, – *"All secure below, cockpit steering disabled, standing by for brake release."* This verifies that the tractor brakes are on, chocks are removed, loading bridge is retracted and / or plane mates clear, and the ramp area is clear.
- When ready to pushback, the Captain will check Door Annunciator Lights extinguished and advise Guideman – *"Parking brake released, cleared to push."*
- At end of pushback, Guideman will advise – *"Parking brake parked,"* and the Captain will respond – *"Parking brake parked, cleared to disconnect interphone."* When the Guideman hears "Parking brake parked" from the Captain, that is considered clearance to disconnect the towbar. If the towbar is not to be disconnected, e.g., the pushback needs to be continued, the Captain will reply with *"Standby"*, followed by further guidance as required.

- Guideman will state – *"Area being cleared, disconnecting interphone."* Captain will acknowledge the Guideman. Guideman will proceed to specified departure salute area and wait.

NOTE

If requested to start engines while final passengers are being boarded and / or bags are being loaded, do not advise Guideman to disconnect interphone until the all secure below is given.

- Captain will flash the nose lights once when he is ready to taxi. Guideman will visually clear the area and give departure salute and display the steering bypass pin indicating to the Captain that the bypass pin is removed and airplane is clear to taxi. Captain will flash the nose lights three times if necessary to recall Guideman to interphone.

Accommodating "Last Minute" Baggage after Engine Start**Forward and Mid Cargo Compartments**

Baggage may be loaded into the forward and mid cargo compartments. During such loading, both engines may be started or operated at idle. The Captain will be requested (on interphone) to idle both engines. Captain should respond with – *"Both engines at idle."* Ground personnel will advise when loading is complete.

Aft Cargo Compartment

Baggage may be loaded into the aft cargo compartment. During such loading, only the left engine may be started or operated at idle. The Captain will be requested (on interphone) to shut down the right engine (if running) and to idle the left engine. Captain should respond with – *"Shutting down the right engine, left engine at idle."* Ground personnel will advise when loading is complete.

Accommodating "Last Minute" Passengers after Engine Start

When not using a jet bridge (stand or stair in use) and additional passengers need to be boarded, the left engine must not be running. The Captain will be requested (on interphone) to shut down the left engine and to idle the right engine. The Captain should respond with – *"Shutting down the left engine, right engine at idle."* Ground personnel will advise when boarding is complete and the boarding stand or stair is removed.

Starting Engines Procedure

Captain	First Officer
Advise Guideman When Ready for Pushback or Engine Start at Gate.	
When Cleared to Start Engines by Guideman	
Advise First Officer – <i>"Ready to Start."</i> Check pneumatic pressure. <ul style="list-style-type: none"> • Optimum starting pressure (valve closed) is 15-22 psi. • TWA Optimum starting pressure (valve closed) is minimum 36 psi (may be 1 psi less for each 1,000 feet above sea level). 	AIR CONDITIONING SUPPLY SWITCHES OFF
ENG IGNITIONCONTIN / A or B	Verify ENG IGNITION selected
Advise First Officer – <i>"Starting left engine."</i> L START Switch..... GND or TWA ON <p style="text-align: center;">NOTE</p> If START Switches are inadvertently released, do not re-engage until engine rotation has stopped. <ul style="list-style-type: none"> • Check that L START VALVE OPEN Light illuminates. • Check PNEU PRESS Gage indicates 22 psi or greater. <p style="text-align: center;">CAUTION</p> <i>If starting pressure is below 25 psi, be alert for a hot or hung start.</i>	





Check for increasing oil pressure, N ₂ , N ₁ , and hydraulic pressure.	
	<p>At max motoring (20% N₂ minimum), with approximately 5% N₁ and EGT at or below 100° C (see NOTE 2): FUEL Lever..... ON</p>
Monitor N ₁ , EGT, N ₂ and Fuel Flow	
	As N ₂ reaches 40%, announce – "N ₂ 40%".
<p>At 40% N₂: L START SwitchOFF Check L START VALVE OPEN Light extinguishes.</p>	
Check N ₂ RPM stabilizes at 50-61% (see NOTE 3).	
<p>With left engine stabilized at idle RPM, check:</p> <ul style="list-style-type: none"> • APU or EXT PWR (L) POWER IN USE Light – Extinguished • L CSD OIL PRESS LOW Light – Extinguished • L OIL PRESS LOW Light – Extinguished • L HYD PRESS LOW Light – Extinguished • EGT – 300-480°C • Fuel Flow – 800-1100 pph 	
	Engine Anti-Ice (if required) ON
After pushback is completed and the brakes are parked: unless one engine taxi is planned, start the right engine in the same manner. (For Crossbleed Start see NOTE 4.)	
<p>■ If engines are started at the gate: Advise Guideman when to disconnect electrical power and / or ground air supply if used.</p> <p style="text-align: center;">NOTES</p> <ul style="list-style-type: none"> • Before disconnecting electrical power, ensure that L and R EXT PWR BUS Switches are OFF. • When external power is disconnected check that the EXT PWR AVAIL Light extinguishes. 	





NOTES

1. Engine Warm-up

If the engines have been shut down for more than two hours, it is recommended that the engines be warmed up for five minutes at low power settings (taxi thrust).

2. Starting EGT

- A static (pre-start) EGT of 100°C or greater increases the probability of a hot start. The engine should be motored until EGT is 100°C or below. The starter should not be disengaged when the desired EGT is indicated. Instead, motoring should continue and the Fuel Lever positioned ON at the maximum available N₂ (20% minimum) with approximately 5% N₁.
- Do not exceed starter duty cycle limitation while motoring engine.
- For starting EGT of 425°C through 475°C, record as an Info to Maintenance entry in E6. No Maintenance action is required.
- If EGT limit of 475° is exceeded for any period of time, immediately shut down the engine. Record the peak EGT and duration of over temp in E6. Request maintenance to come out to the aircraft.
- The maintenance technician will go over the condition of the aircraft, i.e., APU bleed air pressure for start and any other condition that might inhibit a successful start, and sign off the logbook if warranted for another engine start attempt. If engine exceeds 475° again, shut it down immediately and log the over temp in the logbook.
- After the maintenance technician has signed off the second attempt a third attempt will be conducted with a start cart for bleed air.
- If engine EGT exceeds 475° again, shut it down immediately and log the over temp in the logbook. Only three attempts will be made, two with aircraft bleed air and one with a start cart.
- **TWA** For 94xx and 96xx airplanes, engine data is displayed on an electronic Engine Display Panel (EDP). N₁, N₂, and EGT Indicator digits will flash when maximum value is exceeded, or when a hot start is imminent.



30 ON
5 OFF
30 ON
5 OFF

OR

30
30
30



3. Idle RPM

Stabilized Idle RPM

Stabilized idle (50-61% N₂) is the speed prior to turning on air conditioning or engine anti-ice. Air conditioning and engine anti-ice tend to substantially lower N₂ idle speeds due to bleed air requirements.

Low Idle RPM

Lower than normal idle RPM (less than 50% N₂) accompanied by a higher than normal idle EGT and possible generator cycling may be an indication that the 13th stage start bleed valve has failed to close. When conditions permit, momentarily advance the Throttle to approximately 65% N₂ and then retard to idle. This action should close the bleed valve resulting in increased idle RPM and decreased EGT. If the original low idle or generator cycling persists after the throttle is retarded to idle, Maintenance action is required.

- Do not advance throttles until parking brakes are parked.
- At high altitude airports throttle may have to be advanced beyond 65% N₂.

High Idle RPM

Higher than normal idle RPM (by approximately 10%) may indicate actuation of the approach idle solenoid. The MEL permits dispatch with one or both engines operating in approach idle. Refer to MEL SYSTEM 73 – ENGINE FUEL AND CONTROL for restrictions.





4. Crossbleed Start

- Ensure that area to the rear of the operating engine is clear to avoid the possibility of jet blast damage.
- PNEU X-FEED VALVE Levers – Both OPEN
- AIR COND SHUTOFF Switch – OVRD
- Advance Throttle of operating engine slowly to obtain a minimum duct pressure of approximately 36 psi (approximately 80% N₂).
- Using normal starting procedures, start second engine.
- When ENG START Switch is positioned OFF, reduce Throttle to idle on engine supplying crossbleed air.
- AIR COND SHUTOFF Switch – AUTO
- PNEU X-FEED VALVE Levers – As required

5. Air Conditioning

Prior to starting right engine:

To provide maximum passenger comfort, after left engine has stabilized at idle RPM, the left air conditioning pack may be turned on (L PNEU X-FEED VALVE Lever – CLOSED; LEFT AIR CONDITIONING SUPPLY Switch – AUTO).

For one engine taxi:

L PNEU X-FEED VALVE Lever may remain OPEN if APU air is used to supplement engine bleed air for left air conditioning pack.

6. Post Start Overtemp

A post start overtemp occurs when EGT exceeds 480°C after stabilized idle has been established. If post start EGT enters the 480 to 590°C range the engine is not required to be shut down but an Info To Maintenance E6 entry is required. If post start EGT exceeds 590°C an immediate shut down and a regular E6 entry and maintenance action are required.

Logging a Post Start Overtemp

When logging a post start overtemp, state idle N₂, if generator was cycling, throttle was being moved, airplane moving, outside temperature, barometric pressure, fuel flow, peak EGT and duration.

7. Engine Anti-ice

If significant precipitation (snow, sleet or freezing rain) is occurring that could adhere to or collect in the engine inlet, turn on engine anti-ice promptly after each engine is started.

Powerback from Gate

Powerback gate departure will be utilized at specific gates as authorized on the airplane parking page in Flight Manual, Part II or as specified on the Flight Plan / Release. The minimum ground personnel compliment for powerback consists of one Guideman and one Wingwalker who is positioned aft of the right wing tip. At some gates two Wingwalkers are required and that requirement will be shown on the parking page in Flight Manual, Part II.

Powerback Procedures

- Five minutes prior to departure, Guideman will initiate ground to cockpit communication. and request – *"Parking brake parked."* Captain will respond – *"Parking brake parked."*
- Complete Before Starting Engines checklist.
- Guideman will advise Captain – *"All secure below, cleared to start engines."* This indicates lower compartment doors closed, chocks are removed, loading bridge retracted and / or plane mates clear.
- When ready to start engines (and having obtained engine start clearance where required), Captain will check all Door Annunciator Lights extinguished and acknowledge – *"Parking brake parked, starting engines."*
- Start both engines using normal start procedures.
- If external power and / or ground air supply is used for start Captain will advise the Guideman when to disconnect the external power and / or ground air supply.
- When deemed appropriate and at Captain's discretion, the Captain will advise Guideman – *"Cleared to disconnect interphone."*

NOTE

If requested to start engines while final passengers are being boarded and / or bags are being loaded, do not advise guideman to disconnect interphone until the all secure below is given.

- Guideman will state – *"Area being cleared, disconnecting interphone."* Captain will acknowledge the Guideman. Guideman will assume a position in front of and slightly to the left of the airplane nose as viewed from the cockpit (same as departure salute position).
- Immediately after both engines are started, First Officer will call for powerback clearance if required (clearance requirements same as for pushback).
- First Officer will advise Captain when powerback clearance is received.
- Complete Before Taxi or Powerback items on Taxi checklist.
- Captain will flash nose lights once to indicate to the Guideman that he / she is ready to begin powerback procedures. To re-establish cockpit to ground communications, flash nose lights three times.

- To facilitate the powerback procedure it will be standard practice, at the direction of the Guideman, to taxi the airplane forward two or three feet before going into reverse thrust. If, for any reason, the airplane is not to come forward, there shall be verbal agreement between the Guideman and the Captain prior to commencing the powerback procedure.

Powerback Signals

After clearing the area, forward and aft, the Guideman will give the come forward signal. As soon as the airplane begins to move Guideman will immediately give the powerback signal by rotating the wands horizontally in a circular motion.

NOTE

Wands must be used both day and night.

Initiation of Powerback

- Captain will release brakes and apply minimum forward thrust to ease airplane slightly forward.
- Upon recognition of forward movement, the Captain will use light braking to stop the airplane while simultaneously pulling both Throttles into the idle reverse detent.
- When both blue ENG REVERSE THRUST Lights illuminate, release the brakes and drop heels to the floor.

NOTE

To prevent further forward movement, it is important that both engines be in reverse idle prior to brake release.

- Monitor Guideman continuously and apply reverse thrust to establish rearward movement. First Officer will monitor thrust. Do not exceed 1.3 EPR. If this limit is exceeded, make an E6 entry and include level and duration. (It is not necessary to return to the gate. The E6 information is for Maintenance purposes only.)
- As soon as airplane is rolling rearward, modulate speed by decreasing thrust. Rearward speed should not exceed that of a normal walk. Normally, idle or slightly above idle reverse thrust will sustain rearward movement. Should idle reverse produce excessive speed, place one engine in forward thrust.
- Flaps will remain fully retracted until taxiing away from the ramp area.
- If exhaust ingestion / fumes enter the cabin during powerback, air conditioning packs should be turned off.
- If necessary to stop powerback for any reason (ground / gate control / Guideman instruction) Captain will come out of reverse, stop airplane with forward thrust and set parking brakes. If Guideman stopped powerback (airplane / equipment movement behind airplane, etc.) he/she will give powerback signal when powerback is to be resumed. If ground / gate control requests powerback be stopped, Captain will flash nose lights once when powerback may be resumed. Guideman will then give powerback signal. If necessary to re-establish interphone communications with Guideman, Captain will flash nose lights three times.

Powerback in a Turn

- When a turn is to be made during powerback operations there shall be a verbal agreement between the Captain and the Guideman as to the direction of the turn.
- The direction of the turn will be referenced to the movement of the tail of the airplane. Also the direction of the turn will refer to the *Guideman's* left or right.
- A turn, during the powerback maneuver, shall commence only on cue from the Guideman. Upon receiving the cue the Captain will turn the steering wheel in the direction of the Guideman's lowered wand.

NOTE

The rearward taxi speed will decrease as the turn is initiated. Avoid making a tight 90° turn as the airplane may come to a complete stop.

- After the required turn is complete, if continued straight back movement is required, the Guideman will revert to the straight back roll motion of the wands. Throughout the powerback turn procedure, the Captain, at his/her discretion, will be expected to continue rearward movement until the come forward signal is given.

Termination of Powerback**CAUTION**

Do not use brakes to stop rearward movement.

- When airplane has reached the desired position, Guideman will give standard forward movement signal.
- Captain will come sharply out of reverse and apply forward thrust.

NOTE

When forward thrust is applied the airplane may not immediately stop. The backward movement will vary depending on ramp slope, prevailing wind, and the power used by the Captain to terminate the powerback.

- Ensure all reverse lights are extinguished.
- If ready to taxi, as the airplane continues to roll slowly forward, the Captain will flash nose lights once to indicate he is ready to taxi.
- Guideman will clear the area and give standard departure salute. If the area is not clear, Guideman will give standard stop signal. When the area becomes clear, Guideman will give the standard departure salute and the Captain will acknowledge by flashing the nose lights once.
- In either case as stated above, the Captain shall, when the salute is received, announce, – "*I have a salute.*"

Ramp Departure

After powerback Captain will initiate taxi out using both engines. One engine taxi may be initiated in the gate / ramp area provided jet blast does not present a hazard to personnel and equipment.

Special Cautions

- Guideman should never give standard stop signal when airplane is in rearward motion. Forward movement signals will be used to stop airplane. After rearward movement has stopped, standard stop signal will be used.
- Do not use brakes when airplane is in rearward motion.
- If brakes are inadvertently applied while in rearward motion and airplane should start to tail tip, move Throttles into forward thrust immediately.

Restrictions

When existing conditions prohibit powerback operations, the Captain shall notify operations as soon as possible that a pushback will be required.

Powerback operations are prohibited if:

- Unable to move airplane rearward with 1.3 EPR.
- There is airplane movement on an adjacent gate.
- Safety goggles are not used by Guideman.

NOTE

Sunglasses are not an approved substitute for safety goggles.

- Wands (lighted at night) are not used by Guideman.
- The Captain determines that equipment / airplane proximity is too close for safe operations.
- Any thrust reverser is inoperative.
- Loose dry snow, slush or melting ice is on ramp surface (see following **NOTES**).
- Heavy rain is falling (see following **NOTES** for definition).
- Flaps and slats are extended.

The **NOTES** below provide guidelines to be used jointly by the Captain and Guideman to determine if powerback procedures can be utilized.

NOTES

- Heavy rain is defined as an amount sufficient to obscure the continuous visual contact between the Guideman and the Captain.
- Hard packed or frozen snow and glaze ice are surface contaminants which present no hazard to visibility or Guideman safety. Powerback operations are approved on these surfaces **except turns are not authorized.**
- If, in the opinion of the Captain, the hard packed snow or ice has begun to thaw and may be blown up from the surface while in reverse thrust, powerback is prohibited.

Powerback may be accomplished with an amber ENG REVERSE UNLOCK Light and / or blue ENG REVERSE THRUST Light inoperative provided applicable MEL (SYSTEM 78 – EXHAUST) requirements are satisfied, e.g., if an amber ENG REVERSE UNLOCK Light is inoperative – at the termination of powerback and prior to taxi the reverser must be confirmed properly stowed in retracted position.

Table of Contents

Taxi

Preface 10.1

Expanded Checklist 10.1

One Engine Taxi 10.2

 General 10.2

 Restrictions 10.2

Visibility from the Cockpit 10.2

Use of the Nose Lights During Taxi 10.3

Taxi Thrust 10.3

Taxiing 10.3

Tire and Wheel Temperature 10.4

 Taxi Speed 10.4

 Braking 10.4

Reverse Thrust 10.4

Jet Blast Data 10.4

Before Takeoff

Preface 15.1

Expanded Checklist 15.1

Takeoff

Takeoff Procedure 20.1

Takeoff Profiles – All Takeoff Flap Settings 20.3

 Normal Procedure (ICAO B Compliant) 20.3

 Noise Abatement Procedure (ICAO A Compliant) 20.4

Runway Alignment 20.5

Takeoff Procedure – Supplemental Information 20.5

Engine Failure Recognition 20.5

Rotation and Initial Climb 20.6

 Initial Climb Procedure 20.6

RNAV Departure (RNAV SID) GFMS / FMS Set-Up Procedure 20.7

 Prior to Takeoff 20.7

 After takeoff at 400 feet AGL 20.7

Procedure to Update RNAV SID or Runway Change
on GFMS / FMS 20.7

Brake Cooling 20.8

Known or Suspected Tire / Wheel Failure 20.8

Crosswind Takeoffs - Dry or Slippery Runway 20.9

Taxi

Preface

The TAXI checklist will be accomplished as follows:

The First Officer will check all items have been accomplished. Any item that cannot be verified as having been accomplished will require a challenge and response. When all items have been accomplished the First Officer will advise the Captain – *"Taxi checklist complete."*

Expanded Checklist

Captain	First Officer
After Guideman has disconnected the tractor and interphone, the Captain will flash nose lights once when ready to taxi. The Guideman will give departure salute when clear to taxi. The Captain will advise First Officer – <i>"I have a salute."</i>	
ENGINE ANTI-ICEAS REQUIRED OFF unless required for anti-ice.	
Check that left wing is clear and call out – <i>"Clear left."</i>	Check that right wing is clear and call out – <i>"Clear right."</i>

NOTES

1. Flap Management with Snow / Slush and / or Freezing Precipitation
Refer to GENERAL – Winter Operations – Taxi.
2. Use of Reverse Thrust During Taxi
 - Reversers should not be used during taxi for stopping or slowing the airplane except in an emergency.
 - After spoilers and auto brake are armed, use of reverse thrust will cause spoilers to deploy and initiate auto braking.
3. O/W HTR WARM Light
The WARM Light may extinguish during taxi, but no action is required because light was illuminated at departure, or inspection was accomplished or was not required.

One Engine Taxi

General

To conserve fuel and reduce brake wear during taxi, one engine taxi with APU operating should be used whenever practicable.

One engine taxi may be initiated in the gate / ramp area provided jet blast does not present a hazard to personnel and equipment. Do not use more than 1.2 EPR for breakaway thrust. If jet blast would present a hazard to personnel or equipment and / or more than 1.2 EPR would be required for breakaway thrust, initiate one engine taxi after clearing gate / ramp area and airplane is on the taxiway.

- Captain should evaluate if taxi time will be sufficient to warrant a one engine taxi.
- In the event that a takeoff delay cannot be absorbed on the gate or is incurred after gate departure, Captain should evaluate estimated hold time and when practicable both engines may be shut down to conserve fuel.
- The APU should be used to supply air to both packs and electrical power to right bus.
- Start (or restart) of the right engine should be accomplished in sufficient time to allow proper completion of all applicable checklists.
- Restart of right engine may be accomplished while the airplane is taxiing (in motion) if in the Captain's judgment a safe taxi operation would not preclude close monitoring of the engine start. If the APU is operating, restart right engine using APU bleed air.
- At Captain's discretion start (or restart) may be accomplished by the first Officer.

Restrictions

One engine taxi is not authorized when:

- Jet blast will be excessive.
- Ramps and taxiways are slippery.
- Icing conditions unless:
 - No significant precipitation (snow, sleet or freezing rain) is occurring that could adhere to or collect in the engine inlet.
- or
- The engine inlet will be checked by Maintenance or authorized deicing personnel prior to restart.

Visibility from the Cockpit

There is an area near the airplane where personnel, obstacles or guidelines on the ground cannot be seen, particularly when looking across the cockpit. The pilot must rely on ground crew communications to a greater extent in the terminal area to insure a safe, coordinated operation.

Use of the Nose Lights During Taxi

Use of the nose landing and taxi lights in the DIM position when practicable will help prevent unnecessary bulb burn-out due to extreme heat build up. Use the BRT position as necessary for visibility and recognition.

Taxi Thrust

To break away from the ramp, release the brakes and smoothly increase throttles and allow the thrust to respond. In tight gate situations, areas with unsecured objects, or if a building is close behind, limit thrust to 1.2 EPR. See Jet Blast Data in this section for additional information regarding taxi-out from a tight gate position.

When adding thrust to start moving, set thrust then wait for the airplane to respond. Don't continually increase thrust until the airplane moves. This results in more thrust than is necessary or desired. Roll forward before turning to avoid the need to use higher thrust.

Taxiing

When entering turns, overshoot the centerline to compensate for the aft position of the main gear which is approximately 70 feet behind the pilot.

A vertical bounce may be noticed in the cockpit between 12-14 knots and 27-30 knots ground speed. It will be more pronounced when the tires have been sitting for an extended period in cold weather. The bounce should stop if speed is changed. The bounce is much less noticeable in the cabin.

To preclude engine FOD, the manufacturer recommends a maximum taxi speed of 20 knots.

The DC-9 has very responsive nosewheel steering and a light nosewheel footprint, especially at aft centers of gravity. On wet / slippery surfaces be especially cautious when initiating turns. If the nosewheels are deflected too rapidly or at too high a ground speed they will lose traction and skid. If the airplane does not turn in response to a steering input this indicates the nosewheels are skidding and heading control will not be regained until speed and / or nosewheel deflection is reduced.

The nosewheel steering wheel can turn the nose gear to greater angles than the rudder pedal steering. Because of the difficulty in judging the steering angle, the handwheel should be used only for taxiing and should not be used to control the airplane on the runway or on high speed turnoffs if the ground speed is in excess of normal taxi speed.

The limit of nosewheel deflection through the steering wheel is 82°. If differential braking, a main wheel skid, turning inertia or some other action causes nosewheel deflection to exceed 82° the steering system will become inoperative and steering lockup will occur. The nosewheel will have to be manually repositioned (by activating steering bypass lever and turning the nosewheel with a towbar) to within the normal limits to restore steering function.

Tire and Wheel Temperature

Taxi Speed

Airplane gross weight, taxi speed and taxi distance all heavily influence tire and wheel temperature and rate of heat rise. Of the operational factors, gross weight and taxi distance are hardly alterable. The one operational element controllable is taxi speed.

Braking

Avoid riding the brakes to maintain proper taxi speed. Intermittent, positive application results in cooler brakes and less wear. Release the brakes while chocked at the gate for best cooling.

Reverse Thrust

Use of reverse thrust under normal taxiing conditions is not authorized. However, during conditions of reduced braking effectiveness, if necessary, reverse thrust may be used in an emergency to assist in slowing the airplane. Keep in mind that the thrust reverse levers are sensitive and require careful attention during application to minimize asymmetric reverse thrust. Application of symmetric reverse thrust is especially important on wet / slippery runways / taxiways.

NOTE

Do not use asymmetric reverse thrust for directional control.

If difficulty in maintaining directional control occurs during reverse thrust operation, reduce reverse thrust symmetrically as required and select forward idle if necessary in order to maintain or regain control.

Jet Blast Data

Where there is a possibility of jet blast damage, the proper throttle technique will be:

- Advance engine thrust to a maximum of 1.2 EPR.
- Retard thrust as soon as possible after the airplane starts to taxi.
- If a tight turn is required in a restricted area, maintain thrust until just before the point where the jet blast area could cause a problem, then close throttles. This should provide sufficient momentum to sustain taxi-out of the congested area.

If 1.2 EPR will not move the airplane in those tight gate areas where there is exposure to jet blast damage, the Captain will request tow-out.

The diagram on the top of the next shows the jet blast profile with engines at 1.2 EPR.

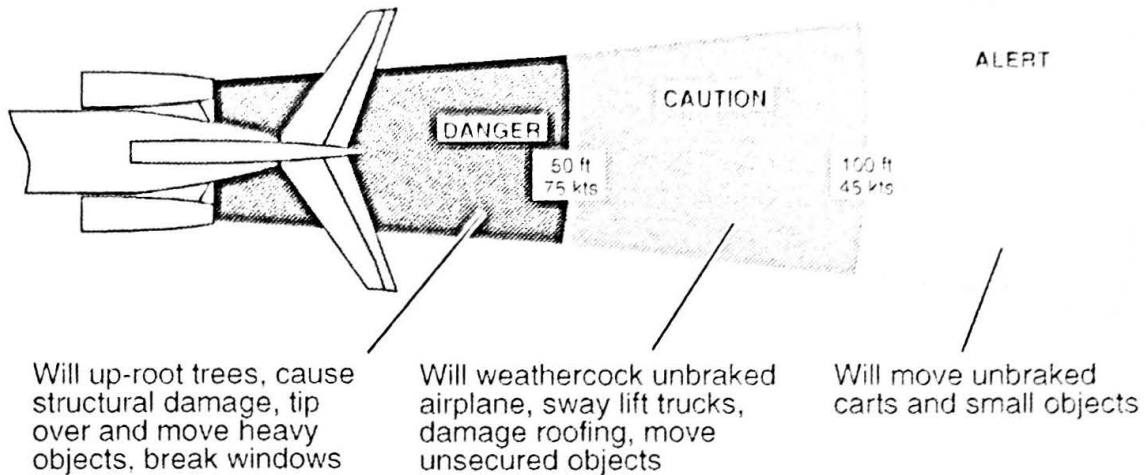

The diagram below shows a typical "problem gate", how best to maneuver the airplane, and the relationship of the jet blast to adjacent objects. Note that the airplane is allowed to move forward several feet before starting the turn to give it a "running start." Then the turn is made at the maximum radius that will provide required clearances. This type of departure will obviously require assistance from ground personnel. Providing this assistance in tight gate areas will normally be standard practice. If it is not provided automatically, the Captain should stop the airplane and request ground assistance at any time clearance is doubtful or known to be marginal.

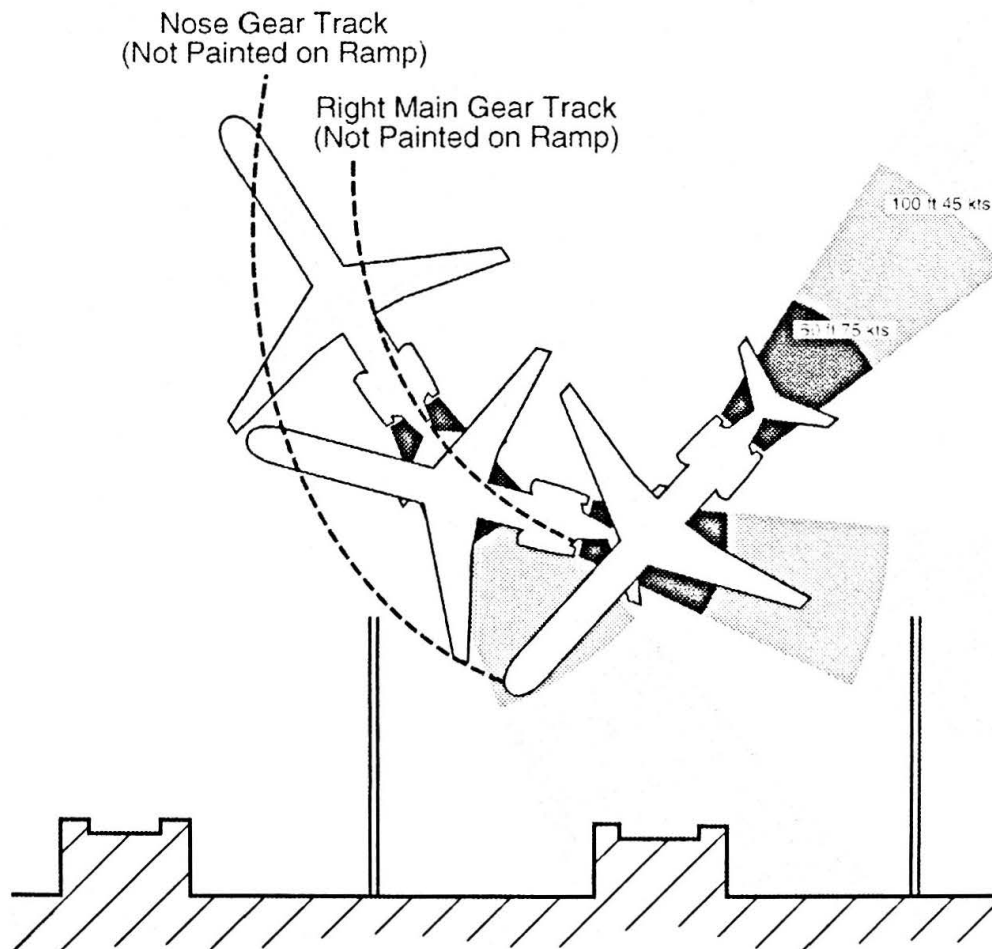

Before Takeoff

Preface

This checklist is accomplished by challenge and response. The First Officer will read the challenge portion using the mechanical checklist. The Captain will respond aloud to all items ensuring accomplishment of all checks and items. The First Officer will also visually verify all items and respond aloud to those items followed by a (‡). When all items have been accomplished the First Officer will advise – "Before Takeoff checklist complete."

Several items on the Before Takeoff checklist are associated with the takeoff data and the takeoff configuration. If a runway or flap setting change occurs, the following Before Takeoff checklist items must be re-accomplished:

- TAKEOFF DATA & BUGS
- FLAPS & SLATS
- STAB TRIM

Following deicing / anti-icing, the mechanical Before Takeoff checklist must be re-accomplished in its entirety.

Expanded Checklist

Captain	First Officer
TAKEOFF DATA & BUGSSET/SET and CROSSCHECKED ‡ RNWY ___ / ___ PWR / CROSSCHECKED	
<p>After closeout information is received Captain will check and First Officer will crosscheck that the following are valid and compatible for existing conditions (temp, wind, etc.) and runway to be used (including intersection, if applicable):</p> <ul style="list-style-type: none"> • Load Closeout data <ul style="list-style-type: none"> – Closeout ZFW – Closeout FOB – Closeout TOW – Closeout weight vs. flight plan max weight for enroute alternate, if required – C. G. – Stab trim 	





- Update ZFW on Fuel Totalizer (if operative)
- Update PMS (if operative)
 - Actual gross weight obtained from:
 - Fuel Totalizer, or
 - Load Closeout if Fuel Totalizer is inoperative.
- Update / verify FMS / GFMS
 - Update ZFW on PERF INIT page
 - Verify the departure procedure – update as necessary.
- Verify TPS data
 - Takeoff thrust
 - V speeds
 - Departure speeds
 - Flap setting
 - Airplane configuration (AC packs, anti-ice, etc.)
 - Engine-out acceleration altitude.
- Reset thrust, bugs, flaps, stab trim or airplane configuration, if required.

Check the following:

- Mach / Airspeed Indicators – Bugs set
- PFD's :
 - No fail legends or no flags
 - V-Command Bars – Wings level (slightly above the horizon)
- Radio Altimeters – Indicate zero, DH bug as desired
- Captain's, First Officer's, and Standby Altimeter:
 - Confirm set to current QNH
 - Altitude Reference Index (bug) – Reset (if required) E/O ACCEL ALT (MSL) shown on the TPS for the assigned runway.
- RMI's – No flags
- ND's – No fail legends or no flags
- Standby Altimeter – Current QNH
- Standby Attitude Indicator – Erect, no flags
- FMA Windows –
 - Thrust – As required
 - ARM – Initial altitude
 - Roll and Pitch – TAK OFF
- ART Switch – As required





<p>FLAPS & SLATS.... ___ / ___ / ___ / ___ TAKEOFF</p> <p>Verbally verify:</p> <ul style="list-style-type: none"> • Final Flap based on TPS ___ • FLAP Thumbwheel ___ • FLAP / SLAT Handle Position ___ • FLAP Position Indicator ___ <p>Verbally verify SLAT TAKEOFF Light is illuminated. (See NOTE 2.)</p>	<p>..... VERIFIED ___ ‡</p> <p>Visually verify:</p> <ul style="list-style-type: none"> • FLAP Thumbwheel • FLAP / SLAT Handle Position • FLAP Position Indicator <p>Visually verify SLAT TAKEOFF Light is illuminated.</p> <p>Announce - "Verified ___ (actual flap setting - 4 / 11 / 17, etc)."</p>
<p>STAB TRIM SET</p> <p>Verbally verify stabilizer trim setting, based on:</p> <ul style="list-style-type: none"> • Load Closeout CG and CG Thumbwheel position • TPS final flap setting and FLAP Thumbwheel position • Long Trim Indicator position • Check Long Trim Indicator is within plus or minus one degree of Stab Trim readout from Load Closeout. 	
<p>SPOILER LEVER ARMED</p> <p>Do not arm spoilers if ABS is inoperative and on TWA airplanes where ABS is not installed.</p>	
<p>ABS TAKEOFF / ARMED</p> <ul style="list-style-type: none"> • AUTO BRAKE - T.O. and ARM • Do not arm ABS if Auto Spoilers are inoperative. • Brake Temperature - Less than 205°C and OVHT Light extinguished. 	





	<p>APU..... AS REQUIRED</p> <p>Shut down unless:</p> <ul style="list-style-type: none"> • Dispatched with engine generator inoperative • If runway is contaminated by standing water, slush, snow or ice, APU should be used for takeoff, if operative. <p>■ If APU will be used for takeoff:</p> <ul style="list-style-type: none"> • APU AIR Switch – OFF • (L and R) APU BUS Switches – ON.
<p>PNEU X-FD'S..... CLOSED</p>	
<p>FLIGHT CONTROLS..... CHECKED</p>	
<p style="text-align: center;">CAUTIONS</p> <ul style="list-style-type: none"> • <i>Do not slam stops when making flight controls check.</i> • <i>Hold Nose Gear Steering Wheel while performing Rudder check.</i> • Slowly move Rudder Pedals, Control Wheel, and Control Column through full travel checking freedom of movement and normal control forces. Check amber SPOILER DEPLOYED Light illuminates during aileron check. When Control Column is moved full forward check blue ELEVATOR PWR ON Light illuminates. (See following NOTES.) 	
<p style="text-align: center;">After Both Engines Are Started for Takeoff</p>	
	<p>HYDRAULIC SYSTEM..... CHECKED and HI / ON</p> <ul style="list-style-type: none"> • ENG HYD PUMP Switches – HI • TRANS HYD PUMP Switch – OFF • AUX HYD PUMP Switch – OFF <p>Check both amber HYD PRESS LOW Lights remain extinguished and both HYD PRESS Gages indicate within green band and quantities are above the red arc.</p> <ul style="list-style-type: none"> • TRANS HYD PUMP Switch – ON • AUX HYD PUMP Switch – ON





<p>ANTI-ICE AS REQUIRED</p> <ul style="list-style-type: none"> • AIR FOIL ANTI-ICE Switches – OFF • Turn on AIR FOIL ANTI-ICE Switches after reaching 1000 feet AFL if icing conditions exist or are anticipated • ENGINE ANTI-ICE Switches – As required • FUEL HEAT – As required. 	
	<p>PACKS AS REQUIRED</p> <ul style="list-style-type: none"> • AIR COND SHUTOFF Switch – AUTO • Ensure Air Conditioning Supply Switches are in AUTO unless takeoff is made with packs off. In which case, position Air Conditioning Supply Switches to OFF. Refer to CLIMB – CRUISE – DESCENT – After Takeoff – Climb – Pack Re-instatement.
<p>T.O. BRIEFING COMPLETED</p> <p>Takeoff briefing – Update as necessary.</p>	
<p>T.O. PA COMPLETED</p> <p>Captain will make Takeoff PA no less than two minutes prior to takeoff.</p> <p>When takeoff is imminent, chime cabin by pressing ATTENDANT CALL Button once.</p> <p style="text-align: center;">NOTE</p> <p>If PA is inoperative, advise First Flight Attendant that chime will be only means of notification. In this case, give chime signal earlier to ensure Flight Attendants have sufficient time to be seated.</p>	
<p>When approaching number one position for takeoff</p>	
<p>ANNUN LTS CHECKED</p> <p>Check blue RUDDER TRAVEL UNRESTRICTED Light is illuminated and all other lights indicate current airplane condition.</p>	





ENGINE IGNITIONCONTIN / A or B

NAV DISPLAY CHECKED, RNWY _____

- Set Nav Display to 10 nm range in MAP mode if conducting RNAV SID.
- Verify correct runway is displayed for takeoff. If reselection of runway is necessary, SID must then be reselected if conducting RNAV SID.
- If reselection of runway and or SID is required a complete re-accomplishment of the route / legs page verification must be performed.
- Verify accuracy of aircraft symbol position relative to runway is acceptable. Refer to RNAV Departure (RNAV SID) GFMS / FMS Set-up Procedure this section.
- At least one pilot shall have terrain display selected, unless weather is such that both pilots need to display weather.

When taking position on the runway

- Both pilots (to the extent practicable) will check final approach area is clear of traffic.
- For night or dusk operations:
 - Turn on flood lights and wing / nacelle lights (may be left off at Captain's discretion)
 - Turn nose lights on DIM.
- First Officer will crosscheck runway heading with airplane heading and that runway is correct runway (verify on ND).
- **TWA** EGPWS must be inhibited by selecting the OVRD when the FMS displays a white or amber "RNP" message in the upper left corner of the EFIS Primary Flight Display (PFD), unless the FMS position is updated at the end of the runway, or verified with actual runway position, by ensuring that, with the Mode Select Panel Range selected to 10 nm, the aircraft symbol is on the runway symbol at the appropriate end of the runway or the aural "Internal GPS card not navigating" message is present.





Just prior to initiating takeoff roll	
<p>NOSE LTS..... BRT</p> <p>Turn nose lights to BRT just prior to initiating takeoff.</p> <p style="text-align: center;">NOTES</p> <ul style="list-style-type: none"> • At Captain's discretion, wing landing lights may be turned on for improved visibility or for recognition. • Limit use of extended wing landing lights when conditions do not require them. They cause slight buffeting and increased fuel consumption. • Lights should be left off if reduced visibility causes scatterback. 	

NOTES

1. Engine Ignition

If CONTIN / A or B position inoperative, select OVRD just prior to takeoff. Observe following Engine Ignition Duty Cycle limitations.

CONTIN / OVRD Ignition (if installed) – Operation in OVRD is limited to 2 minutes ON, followed by 3 minutes OFF; 2 minutes ON, followed by 23 minutes OFF.

A/B Ignition (if installed) – Operation in A, B, BOTH, or OVRD is limited to 10 minutes ON followed by 10 minutes OFF; alternate between A and B positions for CONTINUOUS ignition.

2. Dial-a-Flap Setting

When using flaps 24 for takeoff, do not exceed the 24 mark on the Flap T.O. Sel Wheel. Positioning the wheel even slightly beyond the 24 mark may cause "FULAP" takeoff warning to sound during takeoff roll.

3. Flight Controls Check

Occasionally, in gusty, quartering or tail winds, elevators and their control tabs may assume an asymmetric position fully against their mechanical stops. If this occurs, control columns will feel blocked and an elevator check cannot be performed. This condition is not abnormal, but will require that the check be delayed until direction or velocity of airplane with respect to wind is changed. Whenever the airplane is headed into wind (or taxiing fast enough to cancel any tail wind component), apply pull force to Control Column until it moves full aft position. Forces required may be as high as 85 lbs. Check that blue ELEVATOR PWR ON Light is extinguished. Then apply full nose down push force to activate elevator augmentation system.

Blue ELEVATOR PWR ON Light should illuminate during this part of check.

Takeoff

Takeoff Procedure

Pilot-Flying	Pilot-Monitoring
As airplane is aligned with runway and rolling, advance Throttles to 1.4 EPR or 80% N ₂ (Throttles approximately vertical).	
Check engine instruments for reasonable indications.	
If autothrottle is used for takeoff, call out – "Autothrottle on."	When requested: AUTO THROT Switch... AUTO THROT
Takeoff ThrustSET	
	Check EPR, N ₁ and Autothrottle FMA mode. If necessary adjust Throttle of low EPR engine to EPR reference bug. Make final adjustment before reaching 60 knots.
Check autothrottles in CLMP mode at approximately 60 knots.	
NOTES	
<ul style="list-style-type: none"> • If Throttles do not clamp on takeoff, disconnect autothrottles, takeover Throttles manually and continue takeoff. • Wind gusts may cause CLMP annunciation earlier than expected. 	
Monitor flight and engine instruments. Monitor Caution and Warning panel.	
Crosscheck all engine instruments for reasonableness during the takeoff roll. (This is especially important when icing conditions exist.)	
Prior to 80 knots, the Captain will ensure that all airspeed indications are reasonable. If unreasonable, Captain should consider aborting the takeoff. Refer to the QRH - MANEUVERS - Aborted Takeoff for other considerations.	
At V ₁ , the Captain will remove hand from the top of the throttles.	
	Call out – "80 knots," 'V ₁ ', 'Rotate', 'V ₂ ', and 'V ₂ + 10'" when reached.



20.2 TAXI – TAKEOFF

10-17-07



Call out – " <i>Positive Rate – Gear Up</i> " and give palm up hand signal.	Upon command: Verify positive rate-of-climb. Gear Handle UP All Gear Lights – Check extinguished
	Spoiler Lever DISARMED
	Auto Brake OFF / DISARMED
Accomplish thrust setting changes and flap retraction per profile on TAXI – TAKEOFF – Takeoff Profiles – All Takeoff Flap Settings.	

Takeoff Profiles – All Takeoff Flap Settings

NOTES

- RNAV Departures are based on NAV mode engagement at 400 feet AFL.
- The Special Takeoff Procedures listed in Flight Manual, Part II for specific airports will be substituted for the normal takeoff and initial climb procedure. Those procedures may require a non-standard climb speed and bank angle, however, that combination of climb speed and bank angle will not provide less than 20% margin above stall speed (1.2 Vs meets FAA stall margin requirements).
- The Noise Abatement Procedure will be used when specified in Flight Manual, Part II.

Normal Procedure (ICAO B Compliant)

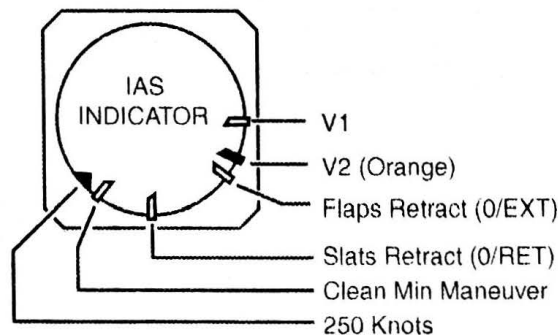
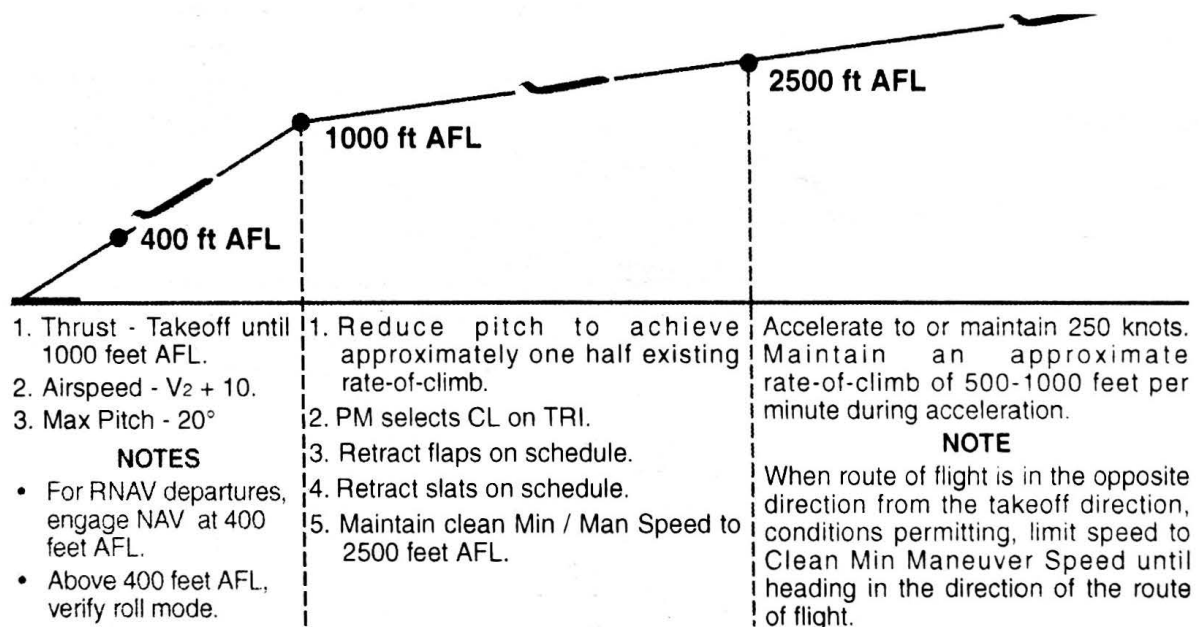

NOTES

- **If more than 15° of bank is required for maneuvering**, increase speed to $V_2 + 20$. This provides approximately 30% margin above stall speed for bank angles up to 30° .
- The GFMS may command up to 27° bank angle (FMS up to 25°) with NAV selected. For this reason the pilot-flying must ensure that the aircraft is properly configured for the airspeed being flown ($V_2 + 20$ with takeoff flaps and / or clean-up at the next higher bug speed) prior to selecting NAV on the DFGC panel.

Noise Abatement Procedure (ICAO A Compliant)

NOTES

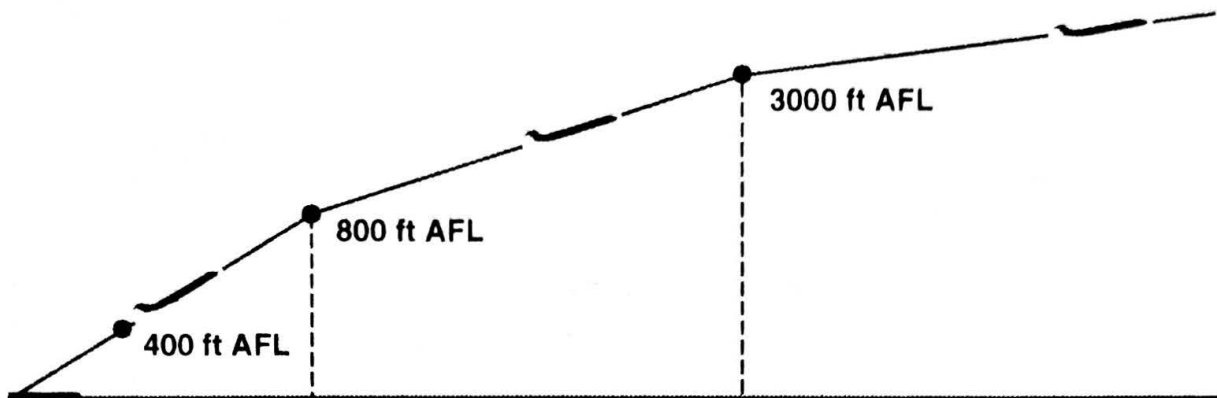

1. Thrust - Takeoff until 800 feet AFL.
2. Airspeed - $V_2 + 10$.
3. Max Pitch - 20° .

NOTES

- For RNAV departures, engage NAV at 400 feet AFL.
- Above 400 feet AFL, verify roll mode.

PM selects CL on TRI (or sets EPR specified in Flight Manual Part II).

1. Reduce pitch to achieve approximately one half existing rate-of-climb.
2. Retract flaps on schedule.
3. Retract slats on schedule.
4. Accelerate to or maintain 250 knots. Maintain an approximate rate-of-climb of 500 - 1000 feet per minute during acceleration.

NOTE

When route of flight is in the opposite direction from the takeoff direction, conditions permitting, limit speed to Clean Min Maneuver Speed until heading in the direction of the route of flight.

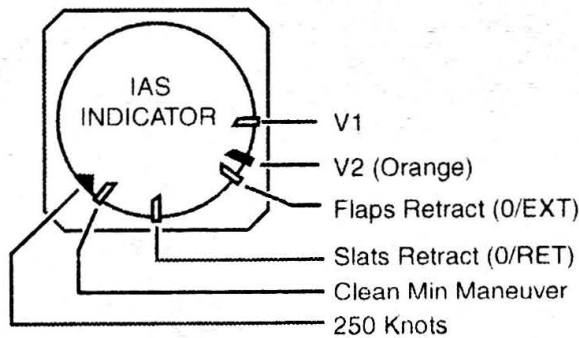

- If more than 15° of bank is required for maneuvering, increase speed to $V_2 + 20$. This provides approximately 30% margin above stall speed for bank angles up to 30° .
- The GFMS may command up to 27° bank angle (FMS up to 25°) with NAV selected. For this reason the pilot-flying must ensure that the aircraft is properly configured for the airspeed being flown ($V_2 + 20$ with takeoff flaps and / or clean-up at the next higher bug speed) prior to selecting NAV on the DFGC panel.

Runway Alignment

Line up slightly left or right of center to avoid runway centerline lights which can cause nosewheel thump during takeoff. With the airplane lined up, verify that the heading indication is the same as the magnetic heading of the runway. If a braked takeoff is being made, check the nose wheel steering wheel for proper alignment prior to releasing brakes.

Takeoff Procedure – Supplemental Information

The pilot making takeoff will advance throttles to 1.4 EPR or 80% N₂ (throttles approximately vertical). Then, if autothrottle is used, pilot-monitoring will move AUTO THROT Switch to AUTO THROT. If throttles are operated manually, rapidly but smoothly increase thrust to takeoff EPR. After takeoff thrust is manually or automatically set, Captain's right hand will be kept on top of throttles until reaching V₁. At V₁, the Captain will remove hand from the top of the throttles. The pilot-monitoring will guard throttles.

When using autothrottle, check FMA annunciates correct EPR mode and changes to CLMP at approximately 60 knots. If CLMP not indicated by 60 knots, disconnect autothrottle.

NOTE

Wind gusts may cause CLMP annunciation earlier than expected.

Pilot-monitoring will verify takeoff EPR is set and call out – "80 knots," "V₁," "ROTATE," "V₂," and "V₂ + 10."

Pilot-monitoring will monitor engine instruments and guard flight controls on all takeoffs.

Normally, a rolling takeoff will be made. However, if takeoff is made from a static position, set throttles to approximately vertical position, ease off brakes, and engage autothrottle.

Make final adjustment to takeoff EPR by 60 knots. Do not readjust EPR after 60 knots except to prevent exceeding engine limits.

Maintain directional control with rudder pedals. At V_R, rotate smoothly to initial takeoff attitude (approximately eight degrees pitch). As airplane becomes airborne, continue rotation to obtain at least V₂ + 10 minimum during initial climb.

NOTE

Tail strike will occur at 10.5° nose up attitude with main gear on ground.

Engine Failure Recognition

The pilot not making the takeoff will monitor engine instruments during takeoff. In event of engine failure, immediately call out – "Left / Right Engine Failure."

If engine failure occurs after V₁, accomplish QRH – MANEUVERS – Takeoff Engine Failure.

Rotation and Initial Climb

Takeoff and initial climb performance depends on rotation to the initial climb attitude at the correct airspeed and proper rate. Early, rapid, or over-rotation is an alarming maneuver and may cause aft fuselage contact with the runway. With the main gear on the ground, the tail cone will contact the runway at a body angle of 10.5°.

Late, slow or under-rotation increases takeoff ground run and decreases initial climb performance. Initiate a smooth continuous rotation at VR to a deck angle of approximately eight degrees. After lift off, climb at a deck angle not to exceed 20°.

Initial Climb Procedure

The standard takeoff and initial climb procedure recognizes operating safety and civic noise considerations. Close adherence to this procedure will result in attaining the desirable altitude over critical noise areas as quickly as possible.

The initial climb speed of $V_2 + 10$ provides at least 20% margin above stall speed (1.2 Vs) up to a 15° bank. Therefore, limit bank angles to 15° after takeoff and initial climb until Clean MIN MAN Speed is attained.

If more than 15° of bank is required for maneuvering, increase speed to $V_2 + 20$. This provides approximately 30% margin above stall speed for bank angles up to 30°.

A maximum of 30° bank is permitted in the following configuration:

- T.O. Flaps / EXT – $V_2 + 20$
- 0 / EXT – Slat Retraction Speed
- 0 / RET – Clean Min Man Speed

NOTE

Noise Abatement Takeoff Procedures listed in Flight Manual Part II for specific airports will be substituted for the normal takeoff and initial climb procedure. Non-standard climb speed and bank angles will provide at least 20% margin above stall speed (1.2 Vs meets FAA stall margin requirements).

RNAV Departure (RNAV SID) GFMS / FMS Set-Up Procedure

NOTES

- For an RNAV departure, a flight director must be operative and used.
- RNAV procedure must be retrieved intact from the GFMS / FMS NAV database and must not be modified.

Prior to Takeoff

On the Mode Select Panel (MSP):

Mode Selector MAP

Range Selector..... 10

Verify proper runway symbol and runway ID are depicted on the Navigation Display (ND) for the departure procedure.

Verify from the GFMS / FMS LEGS page and Navigation Display (ND) that the RNAV waypoints and altitude restrictions agree with those depicted on the particular Jeppesen chart and an active waypoint is depicted in 1L.

RAD / NAV Switch NAV

After takeoff at 400 feet AGL

On Digital Flight Guidance Control (DFGC) Panel:

Mode Selector NAV

Procedure to Update RNAV SID or Runway Change on GFMS / FMS

DEP ARR KeyPRESS

DEP [1L].....PRESS

Departure RUNWAYSELECT

SIDSSELECT

TRANSSELECT

EXEC KeyPRESS

Supplemental Information

- The GFMS may command up to 27° bank angle (FMS up to 25°) with NAV selected. For this reason the pilot-flying must ensure that the aircraft is properly configured for the airspeed being flown ($V_2 + 20$ with takeoff flaps and / or clean-up at the next higher bug speed) prior to selecting NAV on the DFGC panel.
- For RNAV SIDs, if a runway change is received after GFMS / FMS routing was entered, the SID should be re-selected in order to ensure the RNAV routing will begin from the new runway. See Procedure to Update RNAV SID or Runway Change on GFMS / FMS on previous page. **Verify from GFMS / FMS LEGS page and Navigation Display (ND) that the RNAV waypoints and altitude restrictions agree with those depicted on the particular Jeppesen chart and an active waypoint is depicted in 1L. A legs verification check must be reaccomplished through the completion of the RNAV departure to include the appropriate transition.**
- If the departure procedure or route does not start at the end of the runway, it may be necessary to use heading select to intercept the desired course for NAV capture.
- At any time during the departure, if NAV data indicates that the airplane is not on the desired course, advise ATC and request a revised clearance.

Brake Cooling

During warm weather on flight segments of less than an hour, or after long taxi, brakes may not adequately cool with gear retracted. An efficient method of cooling is to leave the gear extended for a period after takeoff, assuming no engine failure occurs and no obstacle clearance problem exists during the takeoff. An alternate method is to extend the gear earlier on approach.

Known or Suspected Tire / Wheel Failure

Refer to QRH – LAND – Known or Suspected Tire / Wheel Failure.

Crosswind Takeoffs - Dry or Slippery Runway

When taking off with a crosswind, initially use rudder pedal steering to hold airplane on the runway centerline. As speed increases, use sufficient aileron into the wind to maintain a wings level attitude. Avoid use of too much wheel throw since drag producing spoilers start extending at five degrees control wheel input. Use opposite rudder as necessary for directional control. Smooth rudder control inputs combined with small lateral control inputs will result in a normal takeoff without over-controlling.

The airplane will be in a forward-slip with crossed flight controls at lift-off. A smooth recovery from this forward-slip may be accomplished after lift-off by releasing rudder and aileron inputs and simultaneously establishing a wings level attitude. Remember:

- Swept wing high tail airplanes have a tendency to weathervane on the ground and at rotation.
- Slight forward pressure on the yoke during takeoff roll assists in maintaining control.

On slippery runways when making a takeoff with a crosswind, the same technique is recommended with the following additional considerations. The airplane should be lined up on the runway before applying thrust. During takeoff on icy or slippery runway, degraded pedal steering capability and possibility of nose wheel side-slipping due to decreased friction must be recognized and corrective action must be anticipated. Commence takeoff roll with the control column held slightly forward of neutral to improve nose wheel traction. Be aware of the additional problems with directional control which may be experienced should a thrust asymmetry occur, particularly at slow speeds.

Snow and slush must be treated with the utmost respect. At high speeds, especially above 100 knots, any kind of moisture on the runway produces drag. Refer to the Performance section for procedures governing takeoff when there is snow or slush on the runway. For allowable depths of snow or slush on the runway, refer to Flight Manual Part I.

Table of Contents

After Takeoff – Climb

Preface 10.1

Expanded Checklist 10.1

Seat Belt Signs 10.4

Pack Reinstatement 10.4

Leveling Off 10.4

Cruise

Preface 15.1

Expanded Checklist 15.1

Cruise Speed 15.2

Company Position Report Requirements 15.2

Descent

Preface 20.1

Expanded Checklist 20.1

Approach Briefing 20.4

 General 20.4

 Day Visual Approach Briefing 20.4

 Instrument Approach or Night Visual Approach Briefing 20.4

 For All Approaches 20.5

 Approach Speed 20.5

 Altimeters 20.6

Speed Reduction 20.7

Seat Belt Signs 20.7

Use of Speed Brakes 20.7

Descent Speed 20.7

Standard Descent Procedure 20.7

Pressurization Monitoring During Descent 20.9

Autothrottle During Descent 20.9

Holding 20.9

 Fuel Economy 20.9

 Approaching the Fix 20.9

After Takeoff – Climb

Preface

The After Takeoff – Climb checklist will be accomplished as follows:

The check of items accomplished prior to 10,000 feet will not begin *until after airplane clean-up as workload permits*. The pilot-monitoring will check that all items are accomplished. Any item that cannot be verified as accomplished will require a challenge and response. ALTIMETERS item will be called out. Each pilot, after resetting altimeters, shall respond – “Set 29.92 and Crosschecked.” The shaded Transition altitude item on the Normal Procedures Checklist indicates the item is actually accomplished at Transition altitude regardless of its sequential location on the checklist.

When all items have been accomplished, the pilot-monitoring will advise - “After Takeoff - Climb checklist complete.”

Expanded Checklist

Pilot-Flying	Pilot-Monitoring
	GEAR UP, NO LIGHTS
	SPOILER LEVER DISARMED
	AUTO BRAKE OFF / DISARMED
	FLAPS / SLATS UP / RET, NO LIGHTS
	ENGINE IGNITION AS REQUIRED OFF unless required for anti-ice.
	PRESSURIZATION and AIR CONDITIONING CHECKED Check for proper indications: <ul style="list-style-type: none"> • CAB ALT and DIFF PRESS Gage • CABIN CLIMB Gage • AIR CONDITIONING PRESS or FLOW Gages If a “packs off” takeoff was made, for pack re-instatement, refer to After Takeoff – Climb – Pack Reinstatement in this section.





	<p>APU..... AS REQUIRED If APU was used for takeoff and is not required: APU MASTER Switch – OFF</p>
<p>Climb modes on DFGC:</p> <ul style="list-style-type: none"> • PERF or VNAV (recommended). • IAS – fly PMS / FMS CLB OPT. • If PMS / FMS is inoperative maintain climb airspeed of: <ul style="list-style-type: none"> – 250 knots to 10,000 feet – 320 knots to Mach crossover – .76 Mach above Mach crossover to cruise altitude. <p style="text-align: center;">NOTE</p> <p>Vertical Speed is not recommended for climbs greater than 2000 feet.</p>	
	<p>Announce – <i>"Checklist complete through clean-up."</i></p>
<p>10,000 Ft MSL</p>	
	<p>FUEL SYSTEM..... CHECKED Check FUEL QTY Gages and Pump Switches to verify proper engine fuel feed.</p> <p>■ If aux tanks contain fuel: AUX TRANS PUMP Switches – AUTO.</p> <hr/> <p>ANNUNCIATOR PANEL..... CHECKED Check that RUDDER TRAVEL UNRESTRICTED Light is extinguished.</p> <hr/> <p>HYDRAULIC PUMPSLOW / OFF</p> <ul style="list-style-type: none"> • ENG PUMP Switches – LOW • TRANS and AUX HYD PUMP Switches – OFF.





	<p>PRESSURIZATION and AIR CONDITIONING CHECKED</p> <ul style="list-style-type: none"> • Check air conditioning system for proper operation. • Check cabin altitude and differential pressure.
<p>Captain – STERILE COCKPIT (10,000 Ft AFL)..... CHIME Advise Flight Attendants of the end of sterile cockpit period by pressing the ATTENDANT CALL Button once. If cruise altitude is 10,000 feet or below the ATTENDANT CALL Button will be pressed upon reaching cruise altitude.</p>	
	<p>Call Out – “Checklist complete through 10,000 ft.”</p>
<p style="text-align: center;">Approaching Transition Altitude</p> <p>ALTIMETERS.....SET, 29.92 and CROSSCHECKED Set BARO to QNE (29.92). Captain and First Officer will set their altimeters and the Standby Altimeter to Standard Altimeter Setting QNE (29.92) and crosscheck that all altimeters agree.</p> <p style="text-align: center;">NOTE</p> <p>If altimeters are reset before reaching Transition Altitude and ATC subsequently directs a level-off at an intermediate altitude, the Captain and First Officer will reset their altimeters and Standby Altimeter to QNH until, once again, cleared to a FL at or above Transition Altitude.</p>	
<p style="text-align: center;">18,000 Ft MSL (or FL 180)</p>	
<p>EXTERIOR LIGHTSAS REQUIRED Verify wing and nacelle flood lights and wing landing lights are off.</p>	
<p>AIRCRAFT PERFORMANCE CHECKED Flight crews MUST verify maximum altitude capability. Refer to the Altitude Capability Chart in the Performance section of this manual, or Altitude Capability Quick Reference Chart in the cockpit, if available.</p> <p style="text-align: center;">NOTE</p> <p>The Altitude Capability Chart is the primary means to determine altitude capability for all configurations. The PMS / FMS OPT / MAX altitudes do not forecast or consider Engine Anti-ice or Wing Anti-ice ON during the climb or sustained cruise, and should not be used as an altitude capability reference.</p>	

Seat Belt Signs

Position SEAT BELT Switch to AUTO when turning this sign off in flight.

Pack Reinstatement

If takeoff was made with air conditioning packs turned off, use following procedure:

As soon as practicable but not less than 400 feet AFL:

AIR CONDITIONING SUPPLY Switches..... AUTO

Position Air Conditioning Supply Switches to AUTO one at a time.

Allow cabin vertical speed to stabilize before turning on second pack.

NOTE

If engine failure occurs on takeoff, the pack associated with operative engine may be turned on at Captain's discretion when above Engine-Out Acceleration Altitude.

Leveling Off

When the autopilot or flight director is engaged in the altitude preselect mode, it is imperative that all annunciations be closely monitored to ensure a smooth transition and level-off at the armed altitude. The DFGS has the capability to capture armed altitudes at high rates of climb or descent (rates may exceed 1000 fpm during last 1000 feet).

Cruise

Preface

The Cruise checklist will be accomplished as follows:

The pilot-monitoring will check that all items have been accomplished. Any item that cannot be verified as accomplished will require a challenge and response. When all items have been accomplished, the pilot-monitoring will advise – *"Cruise checklist complete."*

Expanded Checklist

Pilot-Flying	Pilot-Monitoring
<p>ENGINE and AIRPLANE SYSTEMS.....CHECK</p> <ul style="list-style-type: none"> • Check FMS / PMS to confirm cost Index and appropriate cruise speed for the current altitude, weight and temperature. • Check minimum safe airspeed / mach (VMIN) on Maximum Altitude Capability Quick Reference chart and set top white airspeed bug at VMIN. <p style="text-align: center;">NOTE</p> <p style="text-align: center;">Thrust Rating Indicator (TRI) should remain in CL mode</p>	
	<p>ENGINE SYNCAS REQUIRED</p> <p>Check engine indications are stabilized before selecting engine sync. Normally use N₁ position. If operation unsatisfactory, refer to QRH – ENG – Eng Sync Operation Unsatisfactory.</p>
<p>FUEL SYSTEM.....AS REQUIRED</p> <p>Maintain a fuel log of total fuel and center tank fuel when applicable. Check Fuel Qty Gages and Pump Switches to verify proper fuel feed.</p> <ul style="list-style-type: none"> ■ If aux tanks contain fuel: After each aux tank is empty, position both AUX TANK TRANS Pump Switches OFF. ■ If center tank contains usable fuel: After center tank is empty, as indicated by Center Tank Quantity Gage indicating zero and wing tank quantities decreasing, position CTR TANK Pump Switches OFF. 	





	<p>ART SWITCH AUTO Position ART Switch to AUTO if Standard Thrust takeoff was accomplished. Prevents MASTER CAUTION Lights from illuminating on landing rollout.</p>
	<p>FLAP T.O. SEL WHEEL..... 23°</p>
	<p>ALTIMETERS (RVSM Airspace only)..... CHECK / RECORD When level in RVSM airspace, record the Captain, FO, and Standby altimeter readings. Conduct altimeter check approximately every hour. Refer to SYSTEMS – Flight Instrument, Displays for altimeter tolerances. Also refer to Domestic Flight Manual Part II – AA OPERATIONS Tab – RVSM Airspace.</p>
<p>POSITION REPORT..... AS REQUIRED Refer to Company Position Report Requirements this section</p>	

Cruise Speed

The flight planning system utilizes many inputs to determine best cruise speed for a given flight. Fuel burn, crew costs, aircraft maintenance costs, forecast winds and scheduled flight time are some of the major considerations. Use the PMS / FMS computed econ cruise speed based on the cost index unless these conditions change from the time the flight plan was generated. Confirm that the cruise speed generated by the PMS / FMS is reasonable for the current altitude, weight and temperature.

Company Position Report Requirements

Company position reports are required as follows:

- At the first waypoint after top of climb (TOC).
- Between TOC and BOD - at intervals not to exceed 90 minutes.
- At the last waypoint prior to beginning of descent (BOD).

NOTE

An exception is for flights scheduled for less than 90 minutes air time (OFF to ON).

Descent

Preface

Just prior to descent, accomplish as many of the checklist items as possible.

The pilot-monitoring will check that all items have been accomplished. Any item that cannot be verified as having been accomplished will require a challenge and response. ALTIMETERS item will be called out. Each pilot, after resetting altimeters will respond – *"Set, XX.XX and Crosschecked."* The shaded Transition Level information on the Normal Procedures Checklist indicates that the item is actually accomplished at the Transition Level regardless of its sequential location on the checklist.

When all items have been accomplished the pilot-monitoring will advise, – *"Descent checklist complete."*

Expanded Checklist

Pilot-Flying	Pilot-Monitoring
	<p>MAINTENANCE / SERVICE ITEMS SEND ARMS CODES</p> <p>Check hydraulic and oxygen quantities. Send ARMS code(s) as necessary.</p> <p>Check with Flight Attendants for any cabin items requiring maintenance and / or servicing. Send ARMS code(s) for cabin items along with any other E6 logbook items.</p> <p>Advise Flight Attendants via PA or interphone of expected "touchdown time" so that galleys may be secured in time for landing.</p>
<p>LANDING DATAPREPARED</p> <p>Set Airspeed Reference Bugs to:</p> <ul style="list-style-type: none"> • 0 / RET MIN MAN • 0 / EXT MIN MAN • 15 / EXT MIN MAN (11 / EXT MIN MAN if required) • VREF (orange reference bug) • 80 knots. <p>Prior to final flap selection, set Command Airspeed Bug as required to approach speed. (See NOTE 1.)</p>	



20.2 CLIMB – CRUISE – DESCENT

10-17-07



<p>For descent, fly airspeeds of:</p> <ul style="list-style-type: none"> • Cruise Mach to the 290 knot crossover altitude. • 290 knots to 10,000 feet. • 250 knots or less below 10,000 feet. <p>The PMS / FMS may be operated in the DES NON-OPT mode to maintain the speed profile. Consider an optimum(CI generated) descent speed into those destinations where experience indicate no ATC conflict</p>	<p>PRESSURIZATION SET and CHECKED</p> <p>Set and check the following:</p> <ul style="list-style-type: none"> • LDG ALT – Destination Field Elevation • LDG BARO – Destination Current Altimeter Setting (MSL), if known; if not known set after Changeover • CABIN CLIMB Gage – Indicates descent • DIFF PRESS Gage – Indicates pressure decreasing.
	<p>When landing at hot airports, select colder cockpit / cabin temperatures to pre-cool airplane.</p> <p>ENGINE SYNC OFF</p>
<p>ANTI-ICE AS REQUIRED</p> <p>If icing conditions are anticipated, turn on engine and airfoil anti-ice.</p>	
	<p>WINDSHIELD ANTI-FOG AS REQUIRED</p> <p>Prior to descending into an area with high humidity, turn on windshield anti-fog. Use system for anti-fogging rather than defogging.</p>
<p>EGPWS (TERR DISPLAY) AS REQUIRED</p> <p>At least one pilot shall have terrain display selected, unless weather is such that both pilots need to display weather.</p>	
	<p>Initiate Change-Over Request approximately 25 minutes prior to landing.</p>





Approaching Transition Level

**ALTIMETERS..... SET, XX.XX
and CROSSCHECKED**

Set Baro to (QNH).

Captain and First Officer will set their altimeters and Standby Altimeter to QNH and crosscheck that all altimeters agree.

Altitude Reference Index (Bug) – Set

Radio Altimeter Bug – Set

NOTE

If altimeters are reset before reaching Transition Level and ATC subsequently directs a level-off at an intermediate FL, the Captain and First Officer will reset their altimeters and Standby Altimeter to QNE (29.92) until, once again, cleared to an altitude below Transition Level.

FL 180 (or 18,000 Ft MSL) or Leaving Cruise Altitude, Whichever is Lower

EXTERIOR LIGHTSAS REQUIRED

- For night or dusk operations, turn on wing / nacelle flood lights and wing landing lights (may be left off at Captain's discretion).
- Limit use of extended wing landing lights when conditions do not require them. When extended they cause a slight buffeting as well as increased fuel consumption.
- These lights should remain off if reduced visibility causes scatterback.

HYDRAULIC

SYSTEMHI / ON / CHECKED

- ENG PUMP Switches – HI.

When hydraulic pressures have stabilized at approximately 3000 psi:

- TRANS PUMP Switch – ON
- AUX PUMP Switch – ON
- Brake Pressures – Green band
- Hydraulic Quantities – Checked.

SHOULDER HARNESSSES ON





10,000 Ft MSL

Captain – STERILE CHIME (10,000 Ft AFL)..... ACCOMPLISHED <ul style="list-style-type: none"> • When leaving 10,000 feet or cruise altitude, whichever is lower, advise Flight Attendants of beginning of sterile cockpit period by pressing ATTENDANT CALL Button once.
LANDING PA..... ACCOMPLISHED <ul style="list-style-type: none"> • Descending through 10,000 feet (or departing cruise altitude if lower) but not less than six minutes prior to landing, make PA advising Flight Attendants to prepare for landing.
APPROACH BRIEFING ACCOMPLISHED

Approach Briefing

General

To optimize situational awareness, planning for the approach and landing should begin before departure. The arrival weather forecast, NOTAMS, field conditions, and MEL items should be considered during preflight planning.

The approach briefing is completed prior to top of descent, to the extent possible, to minimize distractions in high-density operations at lower altitudes. The Captain will conduct whatever briefing is appropriate to the situation (e.g., poor weather, inexperienced crewmember, special qualification airports, etc.). The Captain may delegate the briefing to the F/O (Pilot Flying).

Each pilot is responsible for reviewing the applicable approach chart. Set-up for the instrument approach, if available. Crosscheck the Jeppesen page against the GFMS / FMS data for the arrival, approach and missed approach.

Day Visual Approach Briefing

The approach briefing shall include:

- Identify the landing runway (runway changes do not require a new briefing).
- Identify the back-up instrument approach, if available (need not be briefed).

Instrument Approach or Night Visual Approach Briefing

The approach briefing shall include:

- Airport and approach name
- Page number and revision date
- Briefing strip information
- Weather minima - Visibility, RVR, and Ceiling, whichever is applicable.



DC9 Operating Manual

BULLETIN

Subject: Revised Descent Checklist for Electronic Flight Bag Operations	No. DC-9-114
	Date 11-12-07

File: Vol. I – CLIMB - CRUISE - DESCENT 20.4

General

The Descent checklist is revised to support Electronic Flight Bag (EFB) use in the cockpit. A revision bar identifies the new item.

Checklist Procedure



10,000 Ft MSL	
EFB (if used)	OFF and STOWED
If the Electronic Flight Bag (EFB) laptop computer is being used, turn the laptop computer off / sleep / hibernate and stow the computer.	
Captain – STERILE CHIME (10,000 Ft AFL)	ACCOMPLISHED
<ul style="list-style-type: none"> When leaving 10,000 feet or cruise altitude, whichever is lower, advise Flight Attendants of beginning of sterile cockpit period by pressing ATTENDANT CALL Button once. 	
LANDING PA	ACCOMPLISHED
<ul style="list-style-type: none"> Descending through 10,000 feet (or departing cruise altitude if lower) but not less than six minutes prior to landing, make PA advising Flight Attendants to prepare for landing. 	
APPROACH BRIEFING	ACCOMPLISHED

For the DC-9 Fleet Support Team
Captain R. David Johnson

For All Approaches

Other considerations, if appropriate:

- Runway specific engine failure profile
- Weather considerations
- Runway surface conditions
- Terrain considerations
- LAHSO and / or SMGCS procedures
- Any other variables associated with the landing / missed approach
- Alternate airport and routing
- Initial turn off and taxi considerations.

Approach Speed

A minimum of 5 knots is to be applied to V_{REF} (1.3 V_s) for all normal configuration approaches.

The maximum wind correction should not exceed 20 knots. Maintain resulting speed (V_{REF} plus additive) until initiation of landing flare.

Approach Speed / Wind Corrections – Autothrottle OFF

With the autothrottles disengaged or if planned to be disengaged prior to landing, use an approach speed wind correction that is the higher of 1/2 the steady state wind above 20 knots or all of the gusts above the steady winds, based on tower reported winds.

Approach Speed / Wind Corrections – Autothrottle ON

If autothrottles are engaged, ATS will reference to alpha floor (1.3 V_s in landing configuration) or speed selected, whichever is greater. During gust conditions, automatic gust protection will be provided up to a maximum of an additional 5 knots to autothrottle reference speed in use. Therefore, when V_{REF} is being adjusted for a gust increment, select an ATS speed 5 knots less than computed Approach Speed.

In steady state wind conditions which require an additive, selected speed should be required speed since ATS does not measure steady state wind velocity.

Approach Speed / Wind Corrections – Autoland / Autothrottle

During autoland / autothrottle operations, select V_{REF} (1.3 V_s) plus 5 knots regardless of gust or steady state wind conditions. When conditions require gust additives greater than 10 knots or steady state additives greater than 5 knots, autoland operations should be curtailed.

20.6 CLIMB – CRUISE – DESCENT

10-17-07

The following table shows examples of wind additives with a runway heading of 360°.

Example

Reported Wind	Wind Additive*	Approach Speed*
Calm	0	VREF + 5 kts
360 at 15	0	VREF + 5 kts
360 at 32	$32 - 20 = 12 \times 1/2 = 6$	VREF + 6 kts
060 at 15	0	VREF + 5 kts
060 at 12 gust 30	0 + 18 (all the gust)	VREF + 18 kts
040 at 36 gust 42	$36 - 20 = 16 \times 1/2 = 8$ (gust is 6 kts, use higher additive of 8 kts)	VREF + 8 kts

*Approach Speed / Wind Corrections are based on tower reported winds, not wind components.

Increased landing distances may result when speed additives are used, depending on the headwind component. This effect should be considered in respect to allowing the airplane to float. Do not fail to apply appropriate deceleration for existing conditions, utilizing maximum deceleration procedures when necessary. Establish required deceleration as quickly as possible.

Altimeters

Set Altitude Reference Index (Bug) on Captain and First Officer Altimeters and Radio Altimeter Bug to:

- Captain and First Officer Altimeters
 - CAT III – TDZE
 - CAT II – DA
 - CAT I ILS – DA
 - Non-Precision – MDA - rounded up to the next higher 100 feet, if not shown in even hundreds of feet
 - Visual or VFR – At pilot's discretion, may be set to TDZE, 200 feet AFL or an instrument procedure to the landing runway.
 - Radio Altimeter
 - CAT III – DH (50 feet)
 - CAT II – RA
 - CAT I ILS – D(H)
 - Non-Precision – MD(H) or 499 feet if MD(H) is above 499 feet
 - Visual or VFR – At pilot's discretion, may be set for an instrument procedure to the landing runway or 200 feet AGL.

Speed Reduction

Speed reduction should be made using speed brakes in lieu of flap / slat extension, whenever practicable. To provide adequate stall margins during approach, speed brakes must be retracted before extending the flaps and while extending the gear.

Seat Belt Signs

Seat belt signs should be turned on at beginning of descent.

Use of Speed Brakes

While speed brakes are deployed, pilot-flying should keep throttle hand on or near Speed Brake Handle when practicable.

Descent Speed

PMS / FMS cruise Mach should be used down to the 290 knot crossover point.

Standard Descent Procedure

Clean configuration at idle thrust is the preferred method. Descents with flaps and / or speed brakes extended are airspeed limited, noisy, and expensive. Also, at limit speeds, flaps / slats cause buffet. Even though clean descents are preferred, speed brakes should be used when they are needed to expedite traffic flow and maintain desired descent profile. However, if a rapid descent into the terminal area becomes necessary and desired descent rate cannot be achieved with speed brakes or a combination of speed brakes and slats, slow to Flaps 15 extend speed. Utilizing Flaps 15 and idle thrust should satisfy this type of requirement.

There have been instances of unscheduled airplane roll when speed brakes were initially extended during descent. All available information indicates that the most common scenario involves wet weather at departure often followed by rain during flight. The amount of airplane roll has ranged from a requirement for excessive lateral trim to an abrupt 45 degree roll. This condition, which is sometimes accompanied by an increase in SPOILER Lever operating force, typically clears at lower altitudes and cannot be duplicated by maintenance personnel. These trends, and the intermittent nature of the problem, strongly suggest water freezing at altitude in or on the spoiler / speed brake control components.

If an uncommanded roll should occur when deploying the speed brakes, use control inputs as required and immediately stow the speed brake lever.

The trend is toward descents at slower speeds where greater aerodynamic efficiency (increased L/D's) can be achieved. Contrary to some beliefs, "barber pole" descents are not economical. Optimizing the descent requires that we descend at speeds that result in improved glide ratios, and that we begin the descent at distances based on these ratios to the extent that ATC and schedule dependability allow. It is important, to the extent possible, the BOD point on the computer flight plan be observed by coordination with ATC. Every minute of early descent with its subsequent cruise at lower altitude consumes additional fuel. Likewise, any delay in beginning the descent is also inefficient.

20.8 CLIMB – CRUISE – DESCENT

10-17-07

The flight plan BOD, or PMS TOD when available, should be considered the optimum point to begin an unrestricted descent to a landing. However, in actual operations, when it is necessary to compute a BOD point, use the following rule-of-thumb:

1. Determine the altitude difference.
2. Drop the last three digits.
3. Multiply by three.
4. For an unrestricted descent to a landing, add 10 nm.

Example

37000 ft to SL, $37 \times 3 = 111 + 10 = 121$ nm

5. For a descent to an intermediate altitude above 10,000 feet, no additive required.
6. Adjust BOD point for wind (tailwind – earlier BOD, headwind – later BOD):
 - Add two nm for each 10 knots of tailwind at BOD altitude.

Example

For 60 knot tailwind, add 12 nm

- Subtract two nm for each 10 knots of headwind at BOD altitude.

Example

For 60 knot headwind, subtract 12 nm

A three degree descent profile will help maintain a 300 feet / minute cabin rate of descent.

To determine the rate of descent that will produce the three degree profile, multiply the ground speed by six.

Example

$500 \text{ knots} \times 6 = 3000 \text{ fpm}$

Another method is to multiply the miles per minute times three.

Example

$480 \text{ knots} = 8 \text{ mi / min} \times 3 = 24(00)\text{fpm}$

Advise ATC of the point desired to begin descent. ATC will try to approve the request. DME will help considerably. Start a gradual descent, maintaining cruise Mach to the 300 knot crossover point.

Cross-referencing altitude with DME during descent will provide an indication of whether the descent rate must be increased or decreased.

Pressurization Monitoring During Descent

If a higher than normal rate of descent is anticipated or becomes necessary during descent, adjust the pressurization RATE LIMIT Knob as required. Leaving the RATE LIMIT Knob at the index while descending the airplane at a high rate of descent can cause the pressurization system to switch to the standby system (STDBY and TRANSFER LOCKOUT Lights illuminated). This occurs because the system cannot maintain the cabin altitude versus airplane altitude schedule when descents are made at higher than normal rates with the RATE LIMIT Knob at the index.

Autothrottle During Descent

During descent with the autothrottle in "CLMP", manually advance Throttles to start engine spool up as level off altitude is approached. This ensures a smooth transition from the "CLMP" mode to the "SPD" mode of the autothrottle when altitude capture occurs.

A clutch mechanism permits manual positioning of either Throttle without disengaging the autothrottle. However, throttles should not be manually positioned except when in "CLMP" mode or, during descent, when the autothrottle FMA annunciates "LOW LIM". Overriding the autothrottle may cause excessive clutch wear requiring extensive down time to replace the autothrottle servo drive assembly.

Holding

Fuel Economy

Maintain higher altitudes when possible to lower fuel consumption. If a long hold is indicated, request ATC to increase the size of the holding pattern: remember, more thrust and higher fuel consumption is needed in turns. For best fuel economy holding should be conducted in a clean configuration using the minimum practical holding pattern speeds shown in the PMS or on the Holding Speeds and Fuel Flow charts. FAR holding speed limits must be observed unless another speed is authorized.

Approaching the Fix

When holding instructions are received, maintain normal cruise or descent speed until three minutes from the holding fix, then start reducing speed so that proper speed will be attained prior to arriving at the fix and entering the holding pattern. Use DME, when available, to verify estimates. When your flight is advised of a long hold, consider reduction of speed enroute to the holding fix to conserve fuel.

Table of Contents

Before Landing

Preface 10.1

 Pilot-Monitoring 10.1

 Pilot-Flying..... 10.1

Expanded Checklist 10.1

Autobrakes 10.3

Flaps 10.4

 Flap Extension..... 10.4

 Go-Around Flap Setting..... 10.4

 Landing Flaps..... 10.4

Approach

Procedures 15.1

Stabilized Approach Requirements (FAA Order 8400.10) 15.2

ILS Localizer False Course Capture 15.2

Automatic Landings 15.3

 Flight Confidence Checks 15.4

Lower Minimum Equipment Requirements (from MEL) 15.5

 General..... 15.5

 Description 15.5

 Procedures 15.5

Standard Callouts – All Descents, Approaches and Landings

Pilot-Monitoring Callouts 20.1

Pilot-Flying Callouts..... 20.1

Deviation Callouts 20.2

 Airspeed 20.2

 Rate of Descent..... 20.2

 ILS Approaches..... 20.2

 Non-Precision Approaches..... 20.2

Visual Approach

Profile 25.1

Non-Precision Approaches

General 30.1

Procedures 30.2

 General..... 30.2

Lateral Navigation	30.2
Vertical Navigation	30.3
Back Course Approaches	30.3
DC-9 Non-Precision Approach Set-Up	30.4
Requirements for Making Non-Precision Approaches	30.5
Visibility	30.5
Wind	30.5
Weight	30.5
Non-Precision Approach Profiles	30.5
With FAF	30.5
Without FAF - Using Procedure Turn	30.6
Without FAF - Using Base Turn (Teardrop)	30.7
Non-Precision Approach – Crew Coordination Procedures	30.8
Requirements to descend below MDA	30.10
American Airlines Policy	30.10
If Go-Around Required (Prior to Touchdown)	30.10
Go-Around Procedure	30.10

CAT I ILS Approaches

Requirements for Making CAT I ILS Approaches	35.1
Visibility	35.1
Wind	35.1
Weight	35.1
Minimum Airplane Equipment to Begin an ILS Approach	35.1
CAT I ILS Approach Profile	35.2
CAT I ILS Approach – Crew Coordination Procedures	35.3
Requirements to continue Approach below DA / DH (FAR 121.651)	35.4
If Go-Around Required (Prior to Touchdown)	35.4
Go-Around Procedure	35.4

CAT II / III Approaches

General	40.1
Decision Height (DH)	40.1
CAT II	40.1
CAT III	40.1
CAT II / III Summary	40.1
Requirements for Making CAT II Approaches	40.2
Decision Height	40.2
Visibility	40.2
Wind	40.2

Weight	40.2
Runway	40.2
Lighting	40.2
Autobrakes	40.2
Requirements for Making CAT III Approaches.....	40.3
Decision Height	40.3
Visibility	40.3
Wind	40.3
Weight	40.3
Runway	40.3
Lighting.....	40.3
Autobrakes	40.3
Autoland	40.3
Equipment Requirements – CAT II / III.....	40.4
CAT II / III - Crew Coordination Procedures	40.5
Conditions Requiring a Go-Around from a CAT II / III Approach.....	40.6
If Go-Around Required	40.6
Go-Around Procedure	40.6

Landing

Maximum Wind Limits – Landing	45.2
General.....	45.2
Tailwind (AFM)	45.2
Crosswind Component	45.2
Autoland	45.2
Flight Controls	45.3
Auto Spoiler Operation.....	45.3
Reversing	45.3
Manual Braking	45.4

Landing – Supplemental Information

Glide Slope or VASI	50.1
Thrust Control During Approach.....	50.1
Autothrottle Use During Approach.....	50.1
Engine Spool-Up Time	50.1
During Final Approach.....	50.1
Normal Glide Path.....	50.2
Landing Flaps.....	50.2
Visual Approach	50.3
Final Approach	50.3

0.4 APPROACH – LANDING – GO-AROUND

10-17-07

DC-9 Operating Manual **AA**

Main Gear Threshold Crossing Height when Following the ILS Glide Slope	50.4
General Management of the Approach.....	50.4
Approach and Landing Geometry.....	50.6
ILS Approach - Flaps 28	50.6
Estimated Touchdown Point (No Flare) Assuming G/S Transmitter at 1000 ft.....	50.6
Visual Approach - Flaps 28.....	50.6
Estimated Touchdown Point (No Flare) Assuming an Aim Point of 1000 ft.....	50.6
ILS Approach - Flaps 40	50.7
Estimated Touchdown Point (No Flare) Assuming G/S Transmitter at 1000 ft.....	50.7
Visual Approach - Flaps 40.....	50.7
Estimated Touchdown Point (No Flare) Assuming an Aim Point of 1000 ft.....	50.7
Visual Ground Segments - Landing Approach - Flaps 28	50.8
Visual Ground Segments - Landing Approach - Flaps 40	50.8
Pilot Eye Orientation with Ground.....	50.9
Summary	50.9
Landing	50.11
Speed Brakes	50.11
Touchdown	50.11
Bounced Landing Recovery Technique.....	50.12
Directional Control	50.13
Use of Reverse Thrust on Landing	50.13
Autobrakes.....	50.14
Getting the Most from the Brakes	50.15

Landing Under Adverse Weather Conditions

General.....	55.1
Brakes	55.1
Manual Brake Stopping	55.2
Automatic Brake System (ABS).....	55.3
FOD - Reversing at Low Airspeeds	55.3
Dry Runway - Crosswind	55.4
Pitch and Bank Angle Effects	55.5
Slippery Runway - No Crosswind	55.6
Slippery Runway - Crosswind.....	55.7

All Engine Go-Around

If Airborne..... 60.1

 Thrust, Rotate and Flaps 60.1

 Gear 60.1

 Spoilers 60.1

 Speed 60.1

 Climb Out 60.2

If on Runway 60.3

 Autopilot & Auto-throttle 60.3

 Flaps 60.3

 Check 60.3

 Thrust 60.3

 Speed 60.3

 Gear 60.3

 Spoilers 60.3

 Speed 60.4

 Climb Out 60.4

Before Landing

Preface

Accomplish Before Landing checklist by challenge and response as follows:

Pilot-Monitoring

- Call out each item on the mechanical checklist.
- Verify item has been accomplished.
- Call out response and move corresponding switch on mechanical checklist.

Pilot-Flying

Verify and respond to the following items:

- ALTIMETERS
- FLT INSTR & BUGS
- GEAR
- SPOILER LEVER
- FLAPS & SLATS.

In conjunction with the 1000 foot AFL callout, both pilots will visually confirm that all tabs on mechanical checklist are closed-out, and the pilot-monitoring will call out – *“Before Landing checklist complete.”*

Expanded Checklist

Pilot-Flying	Pilot-Monitoring
	<p>HYD PUMPSHI / ON</p> <ul style="list-style-type: none"> • ENG PUMP Switches – HI • TRANS PUMP Switch – ON • AUX PUMP Switch – ON
<p>ALTIMETERS..... SET, XX.XX and CROSSCHECKED Captain’s, First Officer’s, and Standby Altimeter – Set current QNH.</p> <ul style="list-style-type: none"> • Altitude Reference Index (Bug) – Set as required for type of approach (Refer to CLIMB-CRUISE-DESCENT – DESCENT). • Radio Altimeter Bugs – Set as required for type of approach (Refer to CLIMB-CRUISE-DESCENT – DESCENT). 	
<p>FLT INSTR & BUGSSET and CROSSCHECKED Both pilots will check their respective items, verifying each item is correct for landing. They will also crosscheck the other pilot’s items, calling out only noted discrepancies.</p>	





- Extend flaps / slats on schedule.

The only flap settings used during a normal approach and landing are:

- 0 / EXT
- 11 / EXT
- 15 / EXT
- 23 / EXT
- 28 / EXT
- 40 / EXT

NOTE

Use of other flap positions is prohibited.

After initial slat selection (0 / EXT), both pilots will visually verify slats have extended to the correct position (SLAT TAKEOFF Light illuminated) before reducing speed below 0 / RET Min Man or moving Flap Handle beyond 0 / EXT position.

After each subsequent flap / slat extension, check FLAP Position Indicator agrees with FLAP / SLAT Handle and SLAT DISAGREE Light is extinguished.

NOTE

To minimize air loads on flaps / slats, avoid extension and operation near maximum airspeeds. Extend flaps / slats near Min Man Speed for the flap/slat configuration.

<p>Captain – SEAT BELT SIGN / PA ON / COMPLETE</p>	
	<p>TAIL DE-ICE.....AS REQUIRED During approach in icing conditions, turn on tail de-ice one minute prior to selecting landing flaps.</p>
<p>Command – <i>"Gear down."</i></p>	<p>On command: GEAR.....DOWN, THREE GREEN</p>
<p>Captain – SPOILER LEVER ARMED Captain will arm spoilers. Do not arm spoilers if AUTO SPOILER DO NOT USE Light is illuminated.</p>	
	<p>AUTO BRAKES..... AS REQUIRED</p>





	<p>FLAPS & SLATS..... / / LAND</p> <p>When flap / slats are at landing setting, pilot-monitoring will call for this item on checklist.</p> <p>Response will include:</p> <ul style="list-style-type: none"> • FLAP / SLAT Handle Position • FLAPS Position Indicator • SLAT LAND Light illuminated <p style="text-align: center;">NOTE</p> <p>In icing conditions, activate tail deice approximately one minute prior to extending landing flaps.</p>
	<p>ANNUN LTS CHECKED</p> <p>Verify annunciator panel status:</p> <ul style="list-style-type: none"> • Rudder Travel Unrestricted Light illuminated. • GEAR DOOR Light extinguished. • All other lights indicate airplane condition.
	<p>ENGINE</p> <p>IGNITION CONTIN / A or B</p>

Autobrakes

If operative, must be armed prior to landing when any of the following conditions exist:

- Runway length less than 7000 feet
- RVR less than 4000 or visibility less than 3/4 mile
- Runway contaminated with standing water, snow, slush, or ice
- Braking conditions reported less than good.

In addition, use of autobrakes is recommended when landing with gusty winds or crosswinds.

Autobrake settings should be appropriate to the conditions: MAX must be used when minimum stopping distance is required.

After landing, intervene with manual braking as necessary to slow the airplane at the desired rate.

Flaps

Flap Extension

Flaps should not be used for drag purposes in reducing speed – instead, they provide for operation at reduced speeds. Make final flap selection prior to 1000 feet AFL.

NOTE

During visual approaches, maintain a minimum drag configuration as long as practicable to conserve fuel. Observe applicable speed limitations / restrictions.

Go-Around Flap Setting

Climb Limit Weight is determined by thrust, flap configuration, temperature and elevation.

Normally, when landing at airport elevations of 6000 feet or less, use Flaps 15 for go-around. Set approach bug at 15 / EXT. Some airport elevation and temperature combinations may require use of Flaps 11 for go-around.

When airplane is dispatched at a weight which requires Flaps 28° for landing and Flaps 11° for go-around, Dispatch will provide a message in the dispatchers remarks section of the Flight Plan / Release which reads: "Landing weight based on Flaps 28° for landing and 11° for go-around".

Set approach bug at 11 EXT.

At higher elevation airports (4000 feet or more), if temperature at time of landing is significantly higher than planned, or if diverting to another high elevation airport, refer to the Performance section to determine if Flaps 11 will be required for go-around.

Landing Flaps

Flaps 28

Normally used:

- On dry runways which are more than 7000 feet in length.
- At airport elevations above 6000 feet, but may be required at other airports.

NOTE

Landing with Flaps 28 helps conserve fuel by reducing drag compared to Flaps 40.



Flaps 40

Required when anti-skid system (all or part) is or may be inoperative.

Recommended at airport elevations 6000 feet or less when:

- Landing with a tailwind,
- Landing on wet / slippery runways,
- Landing on runways 7000 feet or less in length,
- Braking action is reported less than good,
- In the Captain's judgment use of Flaps 40 is prudent.

NOTE

At typical landing weights, Flaps 40 helps reduce overall stopping distance.

Approach

Procedures

- On all coupled ILS approaches
 - Pilot-Flying when inbound on final approach will:
 - “Follow through” on all flight controls by having one hand firmly gripping yoke and other hand on throttles. Feet should be on the lower part of rudder pedals.
 - Be in position to immediately disconnect autopilot and / or autothrottles if necessary.
 - Pilot-Monitoring when below 1000 feet AFL will:
 - “Guard” flight controls and Throttles by placing one hand in close proximity to the yoke and the other hand in close proximity and behind throttles.
 - Be in position to immediately assume control if necessary.
- Set up DFGS panel.
- Set MDA, DH, DA, as applicable.
- Tune and identify approach facility.
- Use all approach and landing aids available.
- Set Alt Preselect Readout to missed approach altitude:
 - Non-Precision Approach – When ALT HLD annunciates
 - ILS Approach – By 1000 feet

Stabilized Approach Requirements (FAA Order 8400.10)

Significant speed and configuration changes during an approach can complicate aircraft control, increase the difficulty of evaluating an approach as it progresses, and complicate the decision at the decision point; i.e., DA, DH, MDA. A pilot must assess the probable success of an approach before reaching the decision point. This requires the pilot to determine that requirements for a stabilized approach have been met and maintained.

To limit configuration changes at low altitude, the airplane must be in landing configuration by 1000 feet AFL (gear down and landing flaps).

A stabilized approach must be established before descending below the following minimum stabilized approach heights:

- IMC – 1000 feet AFL.
- VMC – 500 feet AFL.

A stabilized approach means the airplane must be:

- At Approach Speed ($V_{REF} + \text{additives}$).
- On the proper flight path at the proper sink rate.
- At stabilized thrust.

These requirements must be maintained throughout the rest of the approach for it to be considered a stabilized approach.

If the stabilized approach requirements cannot be satisfied by the minimum stabilized approach heights or maintained throughout the rest of the approach, a go-around is required.

ILS Localizer False Course Capture

DFGS Localizer false course captures can occur when certain characteristics of a particular localizer beam and the airplane's approach to the beam cause the DFGS to misprocess the deviation signal.

■ If a false course capture occurs:

Select HDG SEL or HDG HLD; then, re-arm approach mode to capture the proper localizer course.

Automatic Landings

When weather conditions are less than ceiling 800 feet / 2 miles:

Tower will not authorize ground or air traffic within the ILS critical area while an airplane is on final approach. When conditions are at or better than 800 feet / 2 miles, they are not required to protect the ILS critical area.

When weather conditions are at or above 800 feet / 2 miles:

Advise tower when making an automatic landing with a request that, if possible, they attempt to keep the ILS critical area clear.

Runway environment must be included in the Captain's scan when below 500 feet on the approach. If a vehicle or airplane is observed on or crossing the runway, or if glide slope or localizer tracking becomes unreliable, disconnect autopilot and fly the remainder of the approach manually. If stabilized approach criteria are not satisfied, execute a go-around.

NOTE

Whenever an automatic landing is made, report it using an ACARS MISC 25 entry (Captain still receives landing credit). In addition, anytime an autoland is attempted, fill out an Electronic Autoland Results form (accessed from the aapilot's.com website by selecting TOOLS – Autoland Form). All other autoland reporting requirements, i.e., E6, ACARS, etc., remain the same.

Flight Confidence Checks

The FAA Approved Lower Minimums Program (LMP) which allows CAT III autoland operations requires that a successful autoland be accomplished and reported at least once every 60 days. This validating autoland is referred to as a "Flight Confidence Check." Ground checks alone are no longer sufficient to maintain LMP status.

Reported autolands are tracked by FOS. Beginning 45 days from the last reported autoland, FOS will append a Special Message to the flight plan requesting an autoland be made and reported. If no autoland is reported, at 60 days since the last reported autoland, MEL 22-90 will be posted in the E6 with the following notation – "Restricted to CAT I Weather Minima Awaiting Flight Confidence Check." This downgrades the weather minima, not the autoland system. An autoland should be accomplished when feasible, weather and traffic conditions permitting.

Flight Confidence Checks may be accomplished on CAT I, CAT II and CAT III runways. Flight Confidence Check must be accomplished in AUTOLAND status (no MEL 22-89 placard). Weather conditions for a flight Confidence Check made after the sixty day limit has expired must be CAT I or better. All other limitations and operational requirements for accomplishing an autoland must also be observed, and consideration given to the information on ILS critical area protection.

NOTES

- Actual CAT II or CAT III approaches must be conducted on CAT II or CAT III runways, as appropriate.
- Standard Procedures remain in place when accomplishing automatic landings using the autopilot.
- Autolands are prohibited if an approach chart NOTE or NOTAM indicates the localizer is unusable inside the threshold of that runway.

After completing a satisfactory Flight Confidence Check, report it via ACARS, fill out an electronic autoland results form accessed from aapilots.com website, and make an "Info to Maintenance" entry in the E6 stating – "*Successful Flight Confidence Check completed.*"

If the autoland is not completed due to an airplane equipment failure, make a regular mechanical discrepancy entry in the E6. If the autoland is not completed due to ILS interference caused by airplanes or equipment operating within the ILS critical area, it should not be considered an unsatisfactory check and, therefore, no E6 entry made.

Lower Minimum Equipment Requirements (from MEL)**General**

A LMP STATUS placard holder is in the E6. The LMP STATUS placard indicates operational status of airplane's lower minimum equipment at dispatch, i.e., the aircraft status in terms of the lowest weather minima authorized, airborne-equipment-wise, in its current condition using the DFGS mode indicated. An autopilot not usable for a coupled approach may or may not be used enroute, depending on whether it's placarded INOP. If placarded INOP, it cannot be used. If not placarded INOP, it may be used enroute but not for a coupled approach below CAT I when the holder indicates NOT CAT II. Certain Maintenance actions to correct an autopilot PIREP can restore its operability for enroute use, but usability for a coupled approach below CAT I is withheld pending a special test specified in the approved LMP Maintenance Program.

Description

The green placard holder has two clear plastic pockets labeled as follows:

- Left pocket – MEL 22-89
- Right pocket – MEL 22-90.

The pockets will be empty or contain placards (AA FORM E-693A) indicating the current AUTOLAND capabilities of the airplane.

Procedures

The airplane is fully AUTOLAND capable when both pockets are empty or if the MEL 22-90 pocket (right side) is placarded requiring a Flight Confidence Check (FCC).

If the MEL 22-89 pocket (left side) contains a placard, the aircraft AUTOLAND capabilities are restricted as described in the remarks section of the placard. The maintenance manuals do not allow credit for an FCC while the LMP is in a downgraded status. Only aircraft with no open MEL 22-89 placards may attempt a Flight Confidence Check (FCC). Possible LMP STATUS in the remarks are:

ILS (CAT II ONLY)

NOT CAT II

NOTE

Crew must verify from logbook review which DFGS can be used enroute and for approach.



DC9 Operating Manual

BULLETIN

Subject: New Standard Callout for Flaps Extension

No. DC-9-117

Date 8-8-08

File: Vol. I – APPROACH - LANDING - GO-AROUND 20.1

General

Each year, flap overspeeds cause millions of dollars in inspection and out of service costs.

As a proactive step toward reducing the high costs associated with flap exceedances, a new callout is added for all approaches. The pilot-monitoring will verbalize the limiting airspeed prior to extending the slats / flaps to the desired setting. This should make both pilots more aware of the limiting airspeed prior to slat or flap extension and help reduce this significant cost.

Procedure

During the approach for landing, the pilot-flying will call for the desired slat or flap setting. The pilot-monitoring will then call out the limiting airspeed for that slat or flap setting and verify current airspeed is below that limit prior to extending the slats / flaps as follows:

Example

PF – “*Slats Extend*”

PM – “*Below 280, Slats Extend*”

PF – “*Flaps (11, 15, 23, 28 or 40)*”

PM – “*Below (limiting airspeed), Flaps (11, 15, 23, 28, or 40)*”

For the DC-9 Fleet Support Team
Captain R. David Johnson

Standard Callouts – All Descents, Approaches and Landings

Pilot-Monitoring Callouts

- "Transition Level" (for Transition Level outside U.S. refer to Enroute Charts).
- "11,000 Feet" MSL (FL 110 if Transition Level is at or below).
- "2500" (by either pilot).
- "1000" AFL on barometric altimeter – "Before Landing checklist complete," after checking that all items on Mechanical Checklist are completed.
- "500" AFL on barometric altimeter – Airspeed \pm Approach Speed and Descent Rate.
- "300" AGL on Radio Altimeter (CAT II and CAT III only).
- "200" AGL on Radio Altimeter (CAT II and CAT III only).
- "100" AGL on Radio Altimeter.
- "50, 40, 30, 20, 10" AGL on Radio Altimeter (if automated voice callouts are inoperative).

NOTES

- "2500", "1000", "500", "100", and "50, 40, 30, 20, 10" are automated voice annunciations and do not need to be called out by the PM unless the automated voice annunciations are inoperative.
- For the additional callouts associated with a particular approach, refer to the Crew Coordination Procedures for that approach.
- When a callout associated with a particular approach, such as "100 above," or "Minimums" closely corresponds to a standard altitude callout, that callout may be omitted.

Pilot-Flying Callouts

"Landing" or "Go Around" at DA, MDA or DH as appropriate on instrument approaches.

Deviation Callouts**Airspeed**

With landing flaps, anytime speed varies more than ± 5 knots from Approach Speed

Rate of Descent

- | When below: | If descent rate exceeds: |
|---------------|--------------------------|
| 2000 | 2000 fpm |
| 1000 | 1000 fpm |
| 300 | 700 fpm |
| • Inside FAF: | 1000 fpm |

ILS Approaches

On final, a callout will be made anytime any crewmember observes a displacement greater than:

- 1/3 dot on LOC
- 1/2 dot on GS.

The other pilot will acknowledge the deviation.

Non-Precision Approaches

On final, a callout will be made anytime any crewmember observes an UNABLE RNP or UNABLE APPROACH message or displacement greater than:

- 2° on a VOR approach
- 5° on an NDB approach, or
- 1/3 dot on a LOC approach, or
- 1 dot course deviation on PFD or CDI for GFMS / FMS non-precision approaches, or
- When the underlying ground based NAVAID indicates a course deviation described above.

The other pilot will acknowledge the deviation.



Visual Approach

Profile

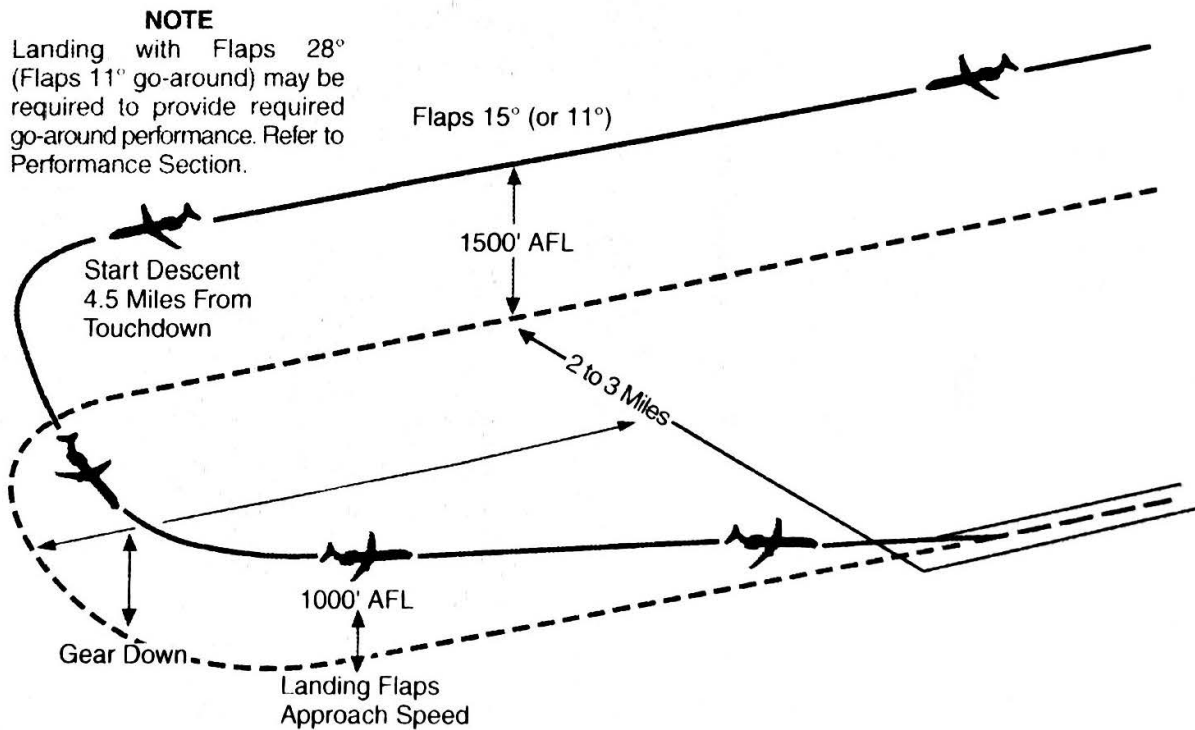

NOTE

Landing with Flaps 28° (Flaps 11° go-around) may be required to provide required go-around performance. Refer to Performance Section.



DC9 Operating Manual

BULLETIN

Subject: Non-ILS Approach Procedures

No. DC-9-116

Date 2-1-08

File: Vol. I – APPROACH – LANDING – GO-AROUND 30.1

General

This bulletin authorizes Non-ILS approaches for all MD80 aircraft to include RNAV (GPS) for GFMS equipped aircraft.

Prior to using these procedures both crewmembers must have received formal training at the Flight Academy after bulletin issuance date.

The following attachment is a complete Non-ILS Approaches section with changes identified by revision bars. Previous procedures published under the "Non-Precision Approaches" in Vol. I must be used if one or both crewmembers have not received the required Non-ILS formal training at the Flight Academy post bulletin issuance date.

Limitations

Crewmembers who have been trained and are authorized to use the procedures in this bulletin shall consider the following FMS limitation no longer valid:

- The following approaches are not authorized for GFMS navigation: ILS, LOC, LOC-BC, and LDA.

For the DC-9 Fleet Support Team
Captain R. David Johnson

Non-ILS Approaches

General

- Two groups of Non-ILS approaches:
 - Those with vertical deviation information (VDI) available inside the FAF (RNAV, VOR and NDB).
 - Those without VDI available inside the FAF (LOC, LOC-BC and LDA).
- RNAV approaches are only authorized with GFMS.
- Use of autopilot, autothrottle (if operative) is recommended on all non-ILS approaches.
- PF – Recommended map scale - 10 miles unless weather or terrain requires different scale.
- ATC radar required on RNAV approaches.
- The ground based nav aid for the non-ILS approach being flown, e.g., VOR, NDB, LOC, etc., is the primary facility for course guidance.
- Except for RNAV approaches, applicable raw data must be monitored throughout the approach.
 - VOR or NDB raw data may be monitored on the RMI.
 - LOC and LDA data may be monitored on the PFD (Expanded Localizer).
 - LOC-BC, one pilot will monitor raw data in the ARC or ROSE mode because Expanded Localizer gives reverse sensing.
- No ground based NAVAIDS required on RNAV approaches.
- The barometric altimeters are used to define MDA and step down altitudes. The radar altimeters should be crosschecked throughout the approach to provide situational awareness.
- The MDA for circling minimums is 1000 feet AFL or charted MDA, whichever is higher. The required visibility for commencing a circling approach is 3 miles or charted minima, whichever is higher.
- A landing following a non-ILS approach is a visual landing which requires sufficient visual references to assure proper alignment and a normal descent profile to the runway of intended landing.

Lateral Navigation

- Non-ILS approaches may be flown by using the GFMS / FMS NAV mode or standard DFGC modes such as VOR / LOC or HDG SEL.
- Flight Director must be ON when using the GFMS / FMS for lateral NAV guidance.
- NAV mode should be engaged when using the GFMS / FMS for guidance.

Vertical Navigation

- Crews must ensure compliance with all altitudes / step down restrictions.
- Any of the following methods may be used for the vertical segment.
 - Vertical Deviation Indicator (VDI) - if available (VOR, NDB, RNAV).
 - Jeppesen published recommended descent rate for the ground speed, if available, rounded up to the next hundred feet.
 - In absence of Jeppesen recommended descent rates, use 700 to 800 fpm. If asked to maintain higher airspeed during any phase of the approach (for example 180 kts to the marker), it may be necessary to utilize a descent rate in excess of 1000 fpm.
 - When a rate of descent greater than 1000 fpm is needed, a special approach briefing should be performed.
 - If an unexpected, sustained rate of descent greater than 1000 fpm is encountered during the final approach segment (inside FAF), a missed approach should be performed.

NOTE

The flight director command bars are tied to vertical speed not the VDI.

- Jeppesen non-ILS approach charts are being revised to provide additional glide path information to facilitate a vertical path from the FAF to the MDA that more closely approximates a constant descent angle. The profile view on these charts provides a reference line that depicts the descent angle for situational awareness.
 - The descent angle (which can vary from 2.5 to 3.77 degrees, or even higher in some cases) is portrayed in brackets.
 - As Non-ILS, Non RNAV approach plates are updated, the dashed line starting at the FAF shows the flight path that is intended to be flown in IMC conditions.
 - The dashed line starting at the MDA shows the extension of the flight path that is intended to be flown if the required criteria to descend below the MDA are satisfied.

- For RNAV approaches, AA DC-9's will use LNAV minimums. LPV and LNAV / VNAV minimums are not authorized. Use caution when briefing an RNAV approach using the briefing strip since LPV or LNAV / VNAV minimums are published here. Look in the landing minimums block to find the LNAV minimums. Below is an example from a non-precision approach chart.
- The table below the profile view provides calculated descent rates for specific ground speeds.

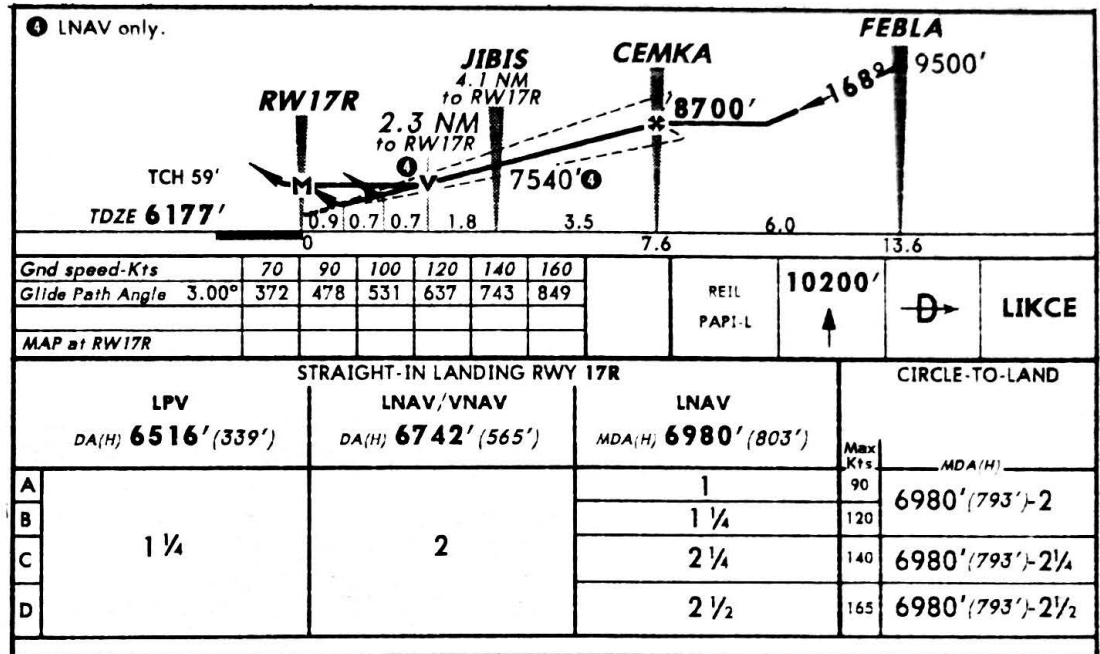

- Step-down and MDA altitudes are limits. Any altitude level-off deviation must be above the step-down altitude or MDA.
- If the required visual references to descend below MDA are satisfied, intercept a normal glide path, disconnect the autopilot and land using a normal rate of descent for landing. Reset Altitude Preselect Readout to the Missed Approach Altitude.
- Once the following conditions are satisfied, an altitude hold annunciation on the FMA does not require a go-around.
 - Visual conditions permit landing
 - Autopilot disconnected
 - Landing declared.

DC-9 Non-ILS Approach Set-Up

	Approach	Roll Mode	PF Display	PM Display	Raw Data	Baro. Alt	Lat Dev. Callouts	Vert Dev. Callouts
VDI Inside FAF	RNAV	NAV	MAP	MAP	N/A	Rounded up MDA	1 Dot	Half Scale
	VOR or VOR / DME	NAV or VOR	MAP or RAW DATA	MAP or RAW DATA	ARC, ROSE or RMI	Rounded up MDA	2 Degrees	Half Scale
	NDB	NAV	MAP	MAP	RMI	Rounded up MDA	5 Degrees	Half Scale
No VDI Inside FAF	LOC	NAV or LOC	MAP or RAW DATA	MAP or RAW DATA	ARC, ROSE or EXPANDED LOC	Rounded up MDA	1/3 Dot	N/A
	*LOC-BC	NAV	MAP or RAW DATA	MAP or RAW DATA	ARC or ROSE	Rounded up MDA	1/3 Dot	N/A
	LDA	NAV or LOC	MAP or RAW DATA	MAP or RAW DATA	ARC, ROSE or EXPANDED LOC	Rounded up MDA	1/3 Dot	N/A

NOTES

- Green approach light will not be present on LOC based approaches.
- Radio Altimeter will be stowed on all non-ILS approaches.
- *LOC-BC approaches – One pilot must monitor RAW DATA on the ND (ARC or ROSE) due to reverse sensing of Expanded Localizer. Ensure front course set on both ND's.
- Expanded Localizer – indicated at the bottom of the Primary Flight Display by a downward pointing triangle moving over a scale consisting of two small circles and a "sidewise E".
- Raw data is always primary guidance for lateral track missed approach decisions.

Non-ILS Approach Requirements

Visibility

- Approach chart Category C minimums (RNAV approaches - Category C LNAV minimums).

Wind

- Tailwind: Max 10 kts (may be further limited by Performance Manual requirements).

With less than 4000 RVR (1200 m) or 3/4 mile

- Crosswind: Max 15 knots.

Temperature

- On RNAV approaches, the BARO VNAV minimum temperature specified note does not apply.

Weight

With less than 4000 RVR (1200 m) or 3/4 mile

- Landing weight based on wet runway limits.

Minimum Aircraft Equipment to Begin the Approach

- GFMS / FMS or LOC or VOR or NDB.
- RNAV - Same as that required for CAT I ILS approaches except no requirement for Autopilot ILS Mode or ILS Receivers. Not authorized for FMS aircraft.

Autobrakes

With less than 4000 RVR (1200 m) or 3/4 mile

- Autobrakes must be used if operative.

Non-ILS Approach Profile with FAF

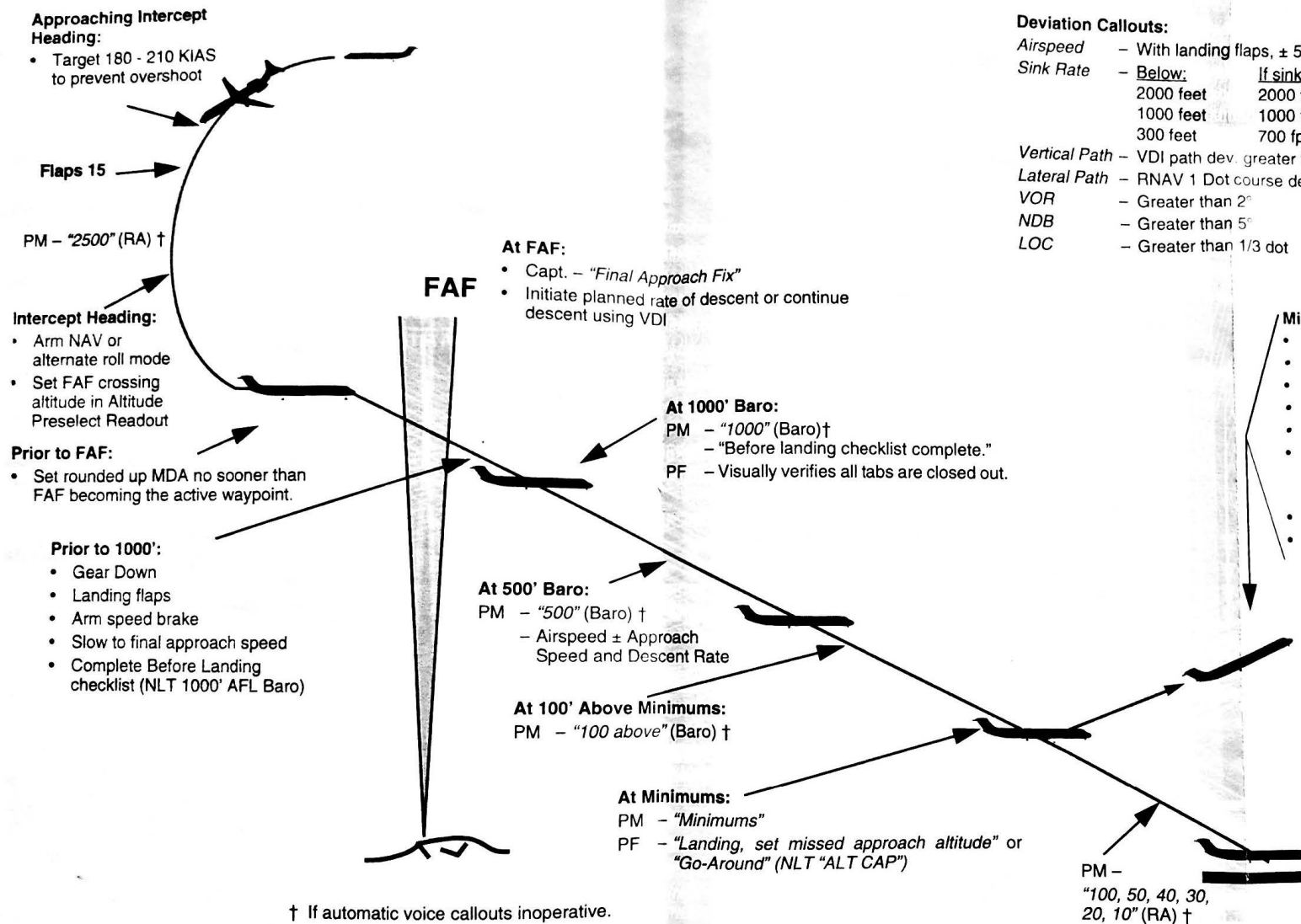

† If automatic voice callouts inoperative.

Deviation Callouts:

- Airspeed** – With landing flaps, ± 5 knots from approach speed
- Sink Rate** – Below: 2000 feet, 1000 feet, 300 feet If sink rate exceeds: 2000 fpm, 1000 fpm, 700 fpm
- Vertical Path** – VDI path dev. greater than half scale
- Lateral Path** – RNAV 1 Dot course dev. on PFD or CDI
- VOR** – Greater than 2°
- NDB** – Greater than 5°
- LOC** – Greater than 1/3 dot

Missed Approach:

- TO / GA, advance throttles
- "Go-around"
- "Flaps 15" (flaps 11 if required)
- "Positive Rate, Gear Up"
- "Set Missed Approach Altitude"
- At or above 400 feet AFL select NAV or desired roll mode
Cannot select NAV if roll mode is in "GO RND".
Select HDG HLD or HDG SEL prior to selecting NAV
- At 1000 feet AFL, "Half Rate", "Climb Power"
- Retract flaps / slats on schedule

Non-ILS Approach Go-Around Requirements:

- A go-around is required if the following conditions occur and a visual approach and landing cannot be accomplished:
- UNABLE APPROACH message.
 - If the airplane symbol on the 10 mile scale is not touching the NAV track.
 - If localizer shows full scale deflection.
 - If the navigation instruments show significant disagreement and visual contact with the runway has not been established.

Without FAF - Using Procedure Turn

NOTE

Approach procedures not having an FAF typically involve a teardrop or procedure turn. Domestically, these procedures are based on TERPS IAP criteria. (Refer to Domestic Flight Manual Part II – Introduction section for expanded information on TERPS criteria.) Internationally, these procedures are typically based on PANS-OPS (ICAO DOC 8168) IAP criteria. (Refer to International Flight Manual Part II – Air Traffic Control section for expanded description of PANS-OPS criteria.)

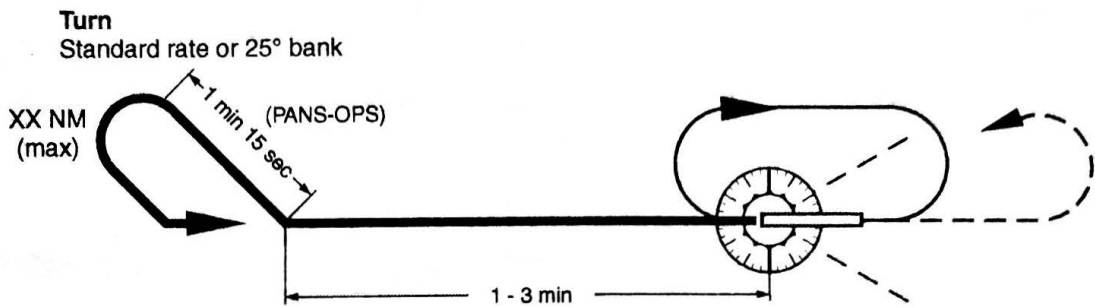

PANS OPS

Entry

Unless the approach specifies a particular entry, direct entry to outbound leg allowed when approach to fix within 30° of outbound track.

Holding Pattern

Use holding pattern to gain alignment with outbound track when direct entry not possible or to descend to fix crossing altitude.

- Approaching Fix
or
No Later Than Procedure
Turn Inbound**
- Gear Down
 - Landing Flaps
 - Approach Speed

Normal Maximum Allowable Descent Rate Inbound

- 1000 fpm

XX NM
(max)

Descent to MDA or Step Down Altitude

- Begin descent from procedure turn minimum altitude when airplane established on in-bound track.
- Set Altitude Preselect Readout to rounded-up MDA to provide FGS level-off guidance at MDA.

MDA

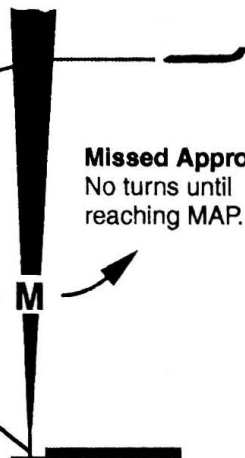

Missed Approach
No turns until
reaching MAP.

Descent below MDA

Do not descend below MDA, unless requirements specified for descent below MDA are satisfied.

Without FAF - Using Base Turn (Teardrop)

NOTE

Approach procedures not having an FAF typically involve a teardrop or procedure turn. Domestically, these procedures are based on TERPS IAP criteria. (Refer to Domestic Flight Manual Part II – Introduction section for expanded information on TERPS criteria.) Internationally, these procedures are typically based on PANS-OPS (ICAO DOC 8168) IAP criteria. (Refer to International Flight Manual Part II – Air Traffic Control section for expanded description of PANS-OPS criteria.)

PANS OPS

Entry

Unless the approach specifies a particular entry, direct entry to outbound leg allowed when approach to fix within 30° of outbound track. If 30° entry does not include reciprocal of inbound course, the entry sector is expanded to include it.

Holding Pattern

Use holding pattern to gain alignment with outbound track when direct entry not possible or to descend to fix crossing altitude.

Turn

- Standard rate or 25° bank
- Rollout on 45° intercept to inbound track.

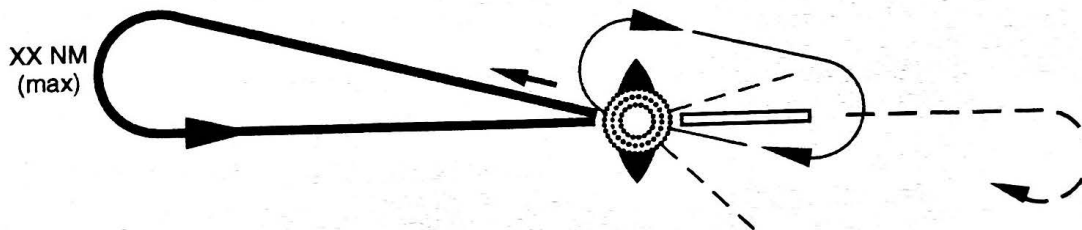

Normal Maximum Allowable Descent Rate Inbound
 • 1000 fpm

XX NM (max)

Approaching Fix or No Later Than Base Turn Inbound
 • Gear Down
 • Landing Flaps
 • Approach Speed

Missed Approach
 No turns until reaching MAP.

Descent to MDA or Step Down Altitude

- Begin descent from procedure turn minimum altitude when airplane established on in-bound track.
- Set Altitude Preselect Readout to rounded-up MDA to provide FGS level-off guidance at MDA.

MDA

Descent below MDA

Do not descend below MDA, unless requirements specified for descent below MDA are satisfied.

Procedures

Prior to commencing approach:

Approach Procedure SELECT

- Approach must be selected from a current nav database (approaches may not be built). Some database approaches do not contain all the waypoints on the approach charts. Named waypoints from the NAV Database may be inserted outside the FAF or after the MAP. Adding or deleting waypoints between the FAF and MAP is not permitted.

CAUTION

Verify the approach chart waypoints, altitudes and sequencing against the GFMS LEGS page to include the missed approach with approach chart. If discrepancy exists, approach chart is controlling.

- On ILS with glideslope out of service approaches, if the GP angle is coded on the LEGS page, do not modify FAF crossing altitude in the GFMS.
- The following conditions must be met for VDI information to be available:
 - Cruise altitude entered on PERF INIT page or VNAV page 2.
 - At least one waypoint with an altitude constraint.

NOTE

Adjust the descent rate to remain on the VDI path while configuring the airplane for landing. Anticipate the changing vertical velocities required to maintain VDI at different ground speeds.

Approaching FAF (or established inbound with no FAF):

Altitude Preselect Readout SET (rounded up) MDA

GFMS APPR Light (green) VERIFY ILLUMINATED

APPR Light (green) should illuminate approximately 2 nm before the FAF. This applies only to RNAV, VOR, NDB approaches utilizing GFMS for lateral guidance.

If the crew observes any of the below status indicators, the HT 9100 has not passed the approach integrity / accuracy checks or cannot meet RNP requirements. Therefore, an alternate means of navigation should be used or the approach should be abandoned.

- APPR Light (green) is extinguished
- RNP is displayed on PFD (steady amber)
- MSG Light on MCDU is illuminated (flashing white)
- UNABLE APPROACH or UNABLE RNP is displayed in the scratchpad on MCDU.

Passing the FAF (or established inbound with no FAF):

V/S AS REQUIRED

- If VDI available (RNAV, VOR, NDB):
 - Use vertical speed to remain on or above the path.
 - A level segment may exist beyond the FAF.
 - The VDI descent path is coded to clear all intermediate step-down fixes.
- If VDI not available (LOC, LOC-BC, LDA):
 - Use Jeppesen published recommended descent rate for the ground speed rounded up to the next hundred feet. If Jeppesen descent rates are not available, the following table is available for guidance:

Estimated Rate of Descent for 3° Path			
110-130 kts GS	130-140 kts GS	140-170 kts GS	170-200 kts GS
600- 700 fpm	700-800 fpm	800-900 fpm	900-1000 fpm

- Maximum descent rate of 1000 fpm unless greater descent rate pre-briefed.

Approaching MDA:

■ **If requirements to continue below MDA are satisfied:**

PF – Call out – *“Landing, set missed approach altitude”*.

■ **If requirements to continue below MDA are not satisfied Execute Missed Approach:**

Captain / PM – Call out – *“Go-Around”*.

Non-ILS Approach – Crew Coordination Procedures

- Either pilot callout – “2500” if automated voice annunciations are inoperative.
- Captain callout:
 - “*Final Approach Fix*”
- On final approach segment, a callout will be made anytime any crewmember observes an UNABLE RNP or UNABLE APPROACH message or displacement greater than -
 - 1 dot course deviation on PFD or CDI for GFMS / FMS non-ILS approaches, or
 - 2° on a VOR approach, or
 - 5° on an NDB approach, or
 - 1/3 dot on an LOC / LOC-BC / LDA approach, or
 - If utilizing VDI, vertical deviation greater than half scale on RNAV, VOR, VOR / DME, or NDB approaches or
 - 1 dot lateral deviation on RNAV approaches.

NOTE

If UNABLE RNP or UNABLE APPROACH message displays, use other means of navigation, or abandon approach and execute a missed approach.

Pilot-Flying	Pilot-Monitoring		
<p>Fly approach.</p> <ul style="list-style-type: none"> • Use vertical speed to initiate planned rate of descent or continue descent referencing VDI. • Maintain vertical track at or above step-down altitudes. 	<p>Monitor Approach.</p> <ul style="list-style-type: none"> • Set Altitude Preselect Readout at rounded-up MDA when FAF becomes active waypoint, • Ensure compliance with step-down altitudes and MDA. <p>Callouts:</p> <ul style="list-style-type: none"> • "1000" AFL on barometric altimeter – "Before Landing Checklist complete" • "500" AFL on barometric altimeter – Airspeed ± Approach Speed and Descent Rate • "100 above" step-down altitude and MDA (bug on barometric altimeter). • "Minimums" (bug on barometric altimeter). 		
Approaching MDA			
<p>■ If required visual references to descend below MDA are satisfied:</p> <table border="1" style="width: 100%;"> <tr> <td data-bbox="140 1164 734 1686"> <ul style="list-style-type: none"> • Call out – "Landing, set missed approach altitude" • Intercept a normal visual glidepath for landing. <p style="text-align: center;">NOTE</p> <p>An ALT HLD annunciation on the FMA does not require a go-around if:</p> <ul style="list-style-type: none"> – Visual conditions permit landing – Autopilot disconnected – Landing declared. </td> <td data-bbox="734 1164 1331 1686"> <ul style="list-style-type: none"> • Set Altitude Preselect Readout to the Missed Approach Altitude. • Direct primary attention to monitoring instruments. <p>Callouts:</p> <ul style="list-style-type: none"> • "100" AGL on Radio Altimeter • "50, 40, 30, 20 10" AGL on Radio Altimeter (if automated voice callouts are inoperative) </td> </tr> </table>		<ul style="list-style-type: none"> • Call out – "Landing, set missed approach altitude" • Intercept a normal visual glidepath for landing. <p style="text-align: center;">NOTE</p> <p>An ALT HLD annunciation on the FMA does not require a go-around if:</p> <ul style="list-style-type: none"> – Visual conditions permit landing – Autopilot disconnected – Landing declared. 	<ul style="list-style-type: none"> • Set Altitude Preselect Readout to the Missed Approach Altitude. • Direct primary attention to monitoring instruments. <p>Callouts:</p> <ul style="list-style-type: none"> • "100" AGL on Radio Altimeter • "50, 40, 30, 20 10" AGL on Radio Altimeter (if automated voice callouts are inoperative)
<ul style="list-style-type: none"> • Call out – "Landing, set missed approach altitude" • Intercept a normal visual glidepath for landing. <p style="text-align: center;">NOTE</p> <p>An ALT HLD annunciation on the FMA does not require a go-around if:</p> <ul style="list-style-type: none"> – Visual conditions permit landing – Autopilot disconnected – Landing declared. 	<ul style="list-style-type: none"> • Set Altitude Preselect Readout to the Missed Approach Altitude. • Direct primary attention to monitoring instruments. <p>Callouts:</p> <ul style="list-style-type: none"> • "100" AGL on Radio Altimeter • "50, 40, 30, 20 10" AGL on Radio Altimeter (if automated voice callouts are inoperative) 		
At MDA			
<p>When ALT HLD annunciates:</p> <table border="1" style="width: 100%;"> <tr> <td data-bbox="140 1792 734 2038"> <ul style="list-style-type: none"> • If ALT HLD annunciates and visual conditions are not met: <ul style="list-style-type: none"> – Captain / PF calls out – "Go-around" • Execute missed approach. </td> <td data-bbox="734 1792 1331 2038"> <ul style="list-style-type: none"> • Set Altitude Preselect Readout to Missed Approach Altitude. • Call out – "Missed Approach Point" </td> </tr> </table>		<ul style="list-style-type: none"> • If ALT HLD annunciates and visual conditions are not met: <ul style="list-style-type: none"> – Captain / PF calls out – "Go-around" • Execute missed approach. 	<ul style="list-style-type: none"> • Set Altitude Preselect Readout to Missed Approach Altitude. • Call out – "Missed Approach Point"
<ul style="list-style-type: none"> • If ALT HLD annunciates and visual conditions are not met: <ul style="list-style-type: none"> – Captain / PF calls out – "Go-around" • Execute missed approach. 	<ul style="list-style-type: none"> • Set Altitude Preselect Readout to Missed Approach Altitude. • Call out – "Missed Approach Point" 		

Requirements to Descend Below MDA

American Airlines Policy

1. If the required visual references to descend below MDA are satisfied, intercept a normal glide path, disconnect the autopilot and land using a normal rate of descent for landing.
2. When the flight director or autopilot levels off at or near the MDA and visual conditions not met, set the Altitude Preselect Readout to the Missed Approach Altitude and execute a missed approach. Do not descend below the MDA.

CAUTION

If go-around is initiated prior to the Missed Approach Point (MAP), do not initiate any turns until reaching the MAP.

3. Required visual references to descend below MDA —
At least **one** of the following runway or runway lighting visual references for the intended runway is required to be distinctly visible and identifiable:
 - Threshold
 - Threshold markings
 - Threshold lights
 - Runway End Identifier Lights (REIL)
 - Visual Approach Slope Indicator
 - Touchdown zone or touchdown zone markings
 - Touchdown zone lights
 - Runway or runway markings
 - Runway lights.

NOTE

The approach lighting system (including the sequenced flasher) is not a substitute for the runway or runway lighting and does not satisfy the requirement for descending below MDA.

4. Descent below MDA will not be commenced or continued unless the airplane is continuously in a position from which a descent to a landing on the intended runway can be made at a normal rate of descent using normal maneuvers, and where that descent rate will allow touchdown to occur within the touchdown zone of the runway of intended landing (FAR 121.651).
5. The flight visibility must not be less than the visibility prescribed in the standard instrument approach procedure being used (FAR 121.651).

If Go-Around Required (Prior to Touchdown)

An autopilot / autothrottle (if engaged) go-around is recommended. (If ground contact is made during an autopilot go-around, revert to manual control.)

Go-Around Procedure

Refer to All Engine Go-Around in this section.

Non-Precision Approaches

General

- Use of autopilot, autothrottle and autobrakes (if operative) is recommended.
- A non-precision approach is a standard instrument approach procedure in which no electronic glide slope is normally provided, e.g., VOR, NDB, LOC, or LDA approaches.
- The ground based nav aid for the non-precision approach being flown, e.g., VOR, NDB, LOC, etc., is the primary facility for course guidance.
- Non-precision approaches using GFMS / FMS are authorized for VOR, VOR / DME and NDB approach procedures.
- A landing following a non-precision approach is a visual landing which requires sufficient visual references to assure proper alignment and a normal descent profile to the runway of intended landing.
- The barometric altimeters are used to define MDA and step down altitudes. The radar altimeters should be crosschecked throughout the approach to provide situational awareness.
- The MDA for circling minimums is 1000 feet AFL or charted MDA, whichever is higher. The required visibility for commencing a circling approach is 3 miles or charted minima, whichever is higher.
- Jeppesen non-precision approach charts are being revised to provide additional glide path information to facilitate a vertical path from the FAF to the MDA that more closely approximates a constant descent angle. The profile view on these charts provides a reference line that depicts the descent angle for situational awareness.
 - The descent angle (which can vary from 2.5 to 3.77 degrees, or even higher in some cases) is portrayed in brackets.
 - The dashed line starting at the FAF shows the flight path that is intended to be flown in IMC conditions.
 - The dashed line starting at the MDA shows the extension of the flight path that is intended to be flown if the required criteria to descend below the MDA are satisfied.
 - AA DC-9's are currently not authorized to use VNAV DA(H) in lieu of MDA(H). Below is an example from a non-precision approach chart.
 - The table below the profile view provides calculated descent rates for specific ground speeds.

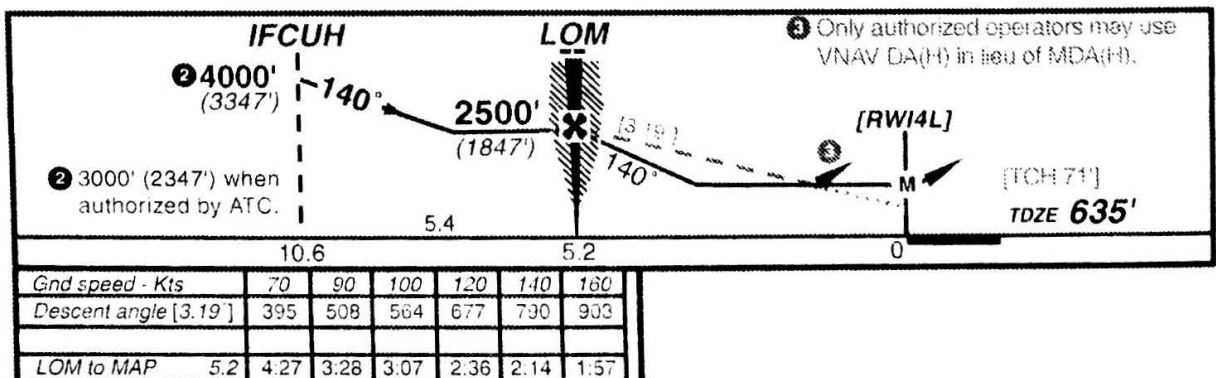

Procedures

The approach briefing will include terrain and obstacle clearance awareness items and use of EGPWS, if operational.

Prior to the Final Approach Fix, set the Altitude Reference Index (Bug) and the DFGC Altitude Preselect Readout to the MDA, rounded up to the next hundred feet (Example: 820 ft is rounded up to 900 ft). Set the Radio Altimeter Bug to the published MD(H) or 499 ft if MD(H) is above 499 ft.

General

- Non-precision approaches may be flown by using the GFMS / FMS NAV mode or standard DFGC modes such as VOR / LOC or HDG SEL.
- LOC, LOC-BC or LDA approaches may not be flown with the GFMS/FMS.
- One pilot must monitor localizer, VOR or NDB raw data on the ND or RMI as appropriate.
- Approach must be selected from GFMS / FMS NAV Database (approaches may not be built). Waypoints not overflown (e.g., due to radar vectors) may be deleted.
- Compare the approach chart waypoints, altitudes and sequencing against GFMS / FMS legs page. Some database approaches do not contain all the waypoints on approach charts. These waypoints may be inserted outside the FAF or after the MAP.

NOTE

Adding or deleting waypoints between the FAF and the MAP is not permitted.

- Use of autopilot, autothrottle and autobrakes (if operative) is recommended. Flight director must be ON when using the GFMS / FMS for lateral NAV guidance.

Lateral Navigation

- Engage NAV Mode when using the GFMS / FMS for guidance, or
- When GFMS / FMS is not available (e.g., no approach procedure in database, UNABLE RNP or UNABLE APPROACH is annunciated), or when flight crew desires to use raw data as navigation mode, use VOR/LOC or HDG SEL.

Vertical Navigation

- Any of the following methods may be used for the vertical segment below the FAF altitude using the vertical speed mode of the Flight Guidance Panel:
 - Jeppesen published recommended descent rate for the ground speed, if available, rounded up to the next hundred feet. (Refer to Non-Precision Approaches, General on previous page).
 - In absence of Jeppesen recommended descent rates, use 700 to 800 fpm recommended.
 - Maximum descent rate of 1000 fpm.

A descent rate of 1000 fpm will normally be considered the maximum allowable for a stabilized approach inside the final approach fix.

- If an expected rate of descent greater than 1000 fpm is planned (e.g., abnormal procedure), a special approach briefing should be performed.
- If an unexpected, sustained rate of descent greater than 1000 fpm is encountered during the final approach segment (inside FAF) a missed approach should be performed.
- MDAs and step-down altitudes are limits. Any altitude level-off deviation must be above the MDA or step-down altitude rather than below.
- If the required visual references to descend below MDA are satisfied, intercept a normal glide path, disconnect the autopilot and land using a normal rate of descent for landing. Reset Altitude Preselect Readout to the Missed Approach Altitude.
- When the flight director or autopilot levels off at or near the MDA, ensure autopilot / flight director level-off does not descend below the MDA. Set Missed Approach Altitude and execute Missed Approach.

Back Course Approaches

For back course approaches, set localizer front course on PF ND.

Approach	Roll Mode	PF Display	PM Display	Raw Data	Baro. Alt	Radio Alt	Deviation
LOC	LOC	MAP or RAW DATA	MAP or RAW DATA	ARC, ROSE or EXPANDED LOC	Rounded up MDA	Actual MD(H)	1/3 Dot
LDA	LOC	MAP or RAW DATA	MAP or RAW DATA	ARC, ROSE or EXPANDED LOC	Rounded up MDA	Actual MD(H)	1/3 Dot
B/CRS LOC	HDG SEL	RAW DATA (HSI)	MAP or RAW DATA	ARC or ROSE	Rounded up MDA	Actual MD(H)	1/3 Dot
VOR or VOR/DME	NAV, VOR or HDG SEL	MAP or RAW DATA	MAP or RAW DATA	ARC, ROSE or RMI	Rounded up MDA	Actual MD(H)	2 Degrees
NDB	NAV or HDG SEL	MAP or RAW DATA	MAP or RAW DATA	RMI	Rounded up MDA	Actual MD(H)	5 Degrees

NOTES

- For Non-Precision approaches using GFMS / FMS, at least one pilot will display raw data.
- For LOC-BC approaches, PF should display raw data on the ND due to reverse sensing of the ILS Localizer pointer on the PFD when the front course is set for a LOC-BC approach. Use the ND for course guidance.
- Expanded LOC is indicated at the bottom of the Primary Flight Display by a downward pointing triangle moving over a scale consisting of two small circles and a "sidewise E".

Requirements for Making Non-Precision Approaches

Visibility

The minimum visibility for the approach is as shown in the minimums table on the approach chart for Category C airplanes.

Wind

- Tailwind: Max 10 kts (may be further limited by Performance section requirements)

With less than 4000 RVR (1200 m) or 3/4 mile

- Crosswind: Max 15 kts

Weight

With less than 4000 RVR (1200 m) or 3/4 mile

- Landing weight based on wet runway limits

Non-Precision Approach Profiles

With FAF

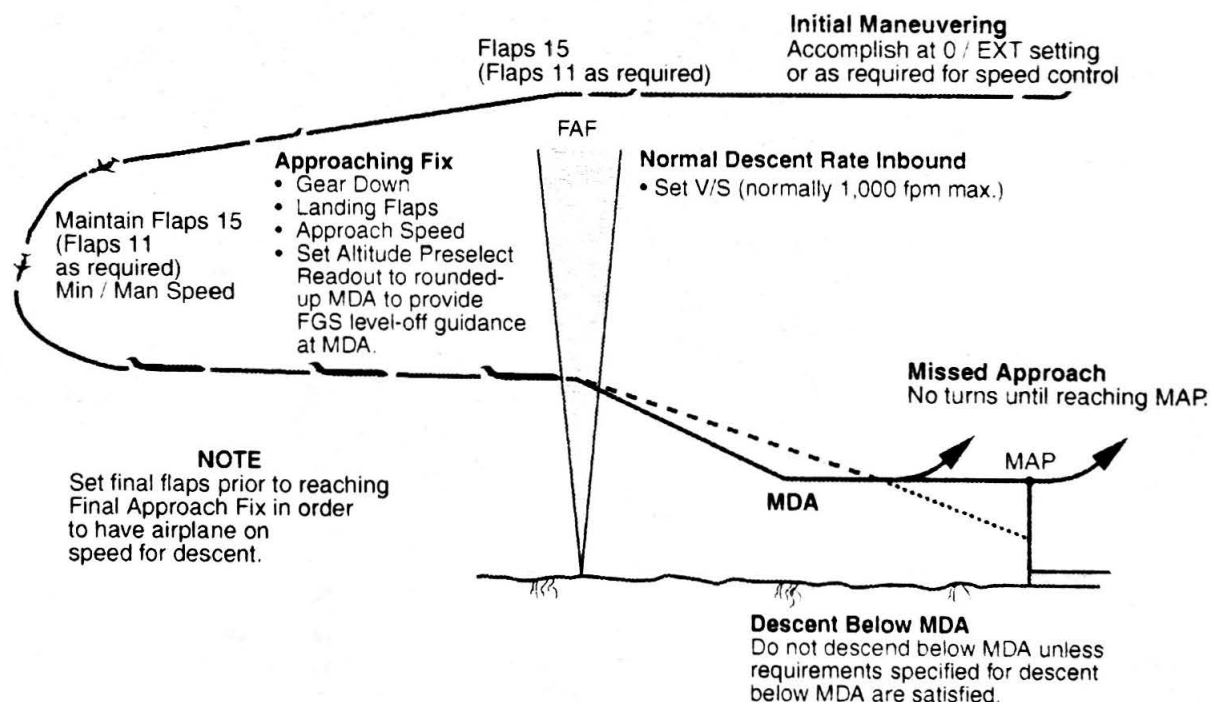

Without FAF - Using Procedure Turn

NOTE

Approach procedures not having an FAF typically involve a teardrop or procedure turn. Domestically, these procedures are based on TERPS IAP criteria. (Refer to Domestic Flight Manual Part II – Introduction section for expanded information on TERPS criteria.) Internationally, these procedures are typically based on PANS-OPS (ICAO DOC 8168) IAP criteria. (Refer to International Flight Manual Part II – Air Traffic Control section for expanded description of PANS-OPS criteria.)

Turn

Standard rate or 25° bank

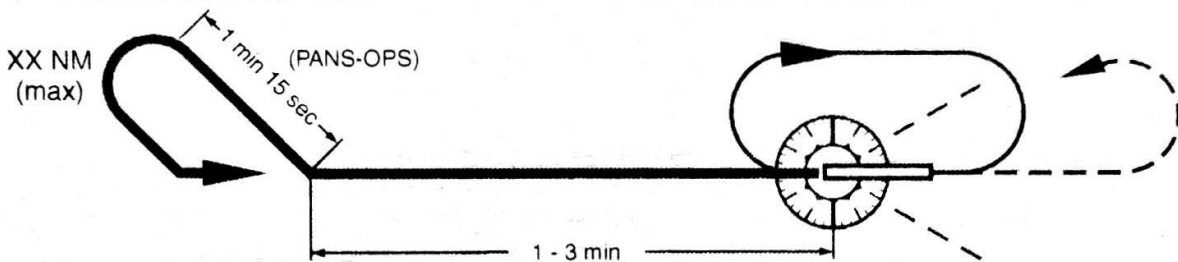

PANS OPS

Entry

Unless the approach specifies a particular entry, direct entry to outbound leg allowed when approach to fix within 30° of outbound track.

Holding Pattern

Use holding pattern to gain alignment with outbound track when direct entry not possible or to descend to fix crossing altitude.

**Approaching Fix
or
No Later Than Procedure
Turn Inbound**

- Gear Down
- Landing Flaps
- Approach Speed

**Normal Maximum Allowable
Descent Rate Inbound**

- 1000 fpm

XX NM
(max)

Descent to MDA or Step Down Altitude

- Begin descent from procedure turn minimum altitude when airplane established on in-bound track.

- Set Altitude Preselect Readout to rounded-up MDA to provide FGS level-off guidance at MDA.

Descent below MDA

Do not descend below MDA, unless requirements

Missed Approach
No turns until reaching MAP.

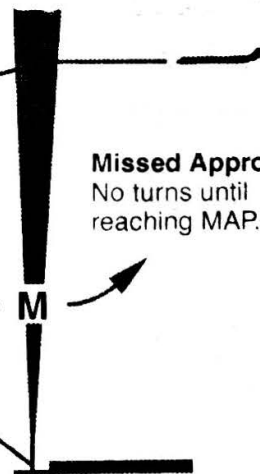

Without FAF - Using Base Turn (Teardrop)

NOTE

Approach procedures not having an FAF typically involve a teardrop or procedure turn. Domestically, these procedures are based on TERPS IAP criteria. (Refer to Domestic Flight Manual Part II – Introduction section for expanded information on TERPS criteria.) Internationally, these procedures are typically based on PANS-OPS (ICAO DOC 8168) IAP criteria. (Refer to International Flight Manual Part II – Air Traffic Control section for expanded description of PANS-OPS criteria.)

PANS OPS

Entry

Unless the approach specifies a particular entry, direct entry to outbound leg allowed when approach to fix within 30° of outbound track. If 30° entry does not include reciprocal of inbound course, the entry sector is expanded to include it.

Holding Pattern

Use holding pattern to gain alignment with outbound track when direct entry not possible or to descend to fix crossing altitude.

Turn

- Standard rate or 25° bank
- Rollout on 45° intercept to inbound track.

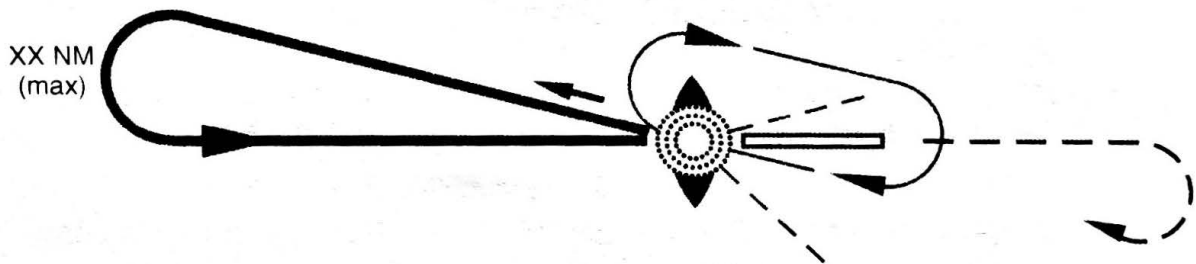

Normal Maximum Allowable Descent Rate Inbound

- 1000 fpm

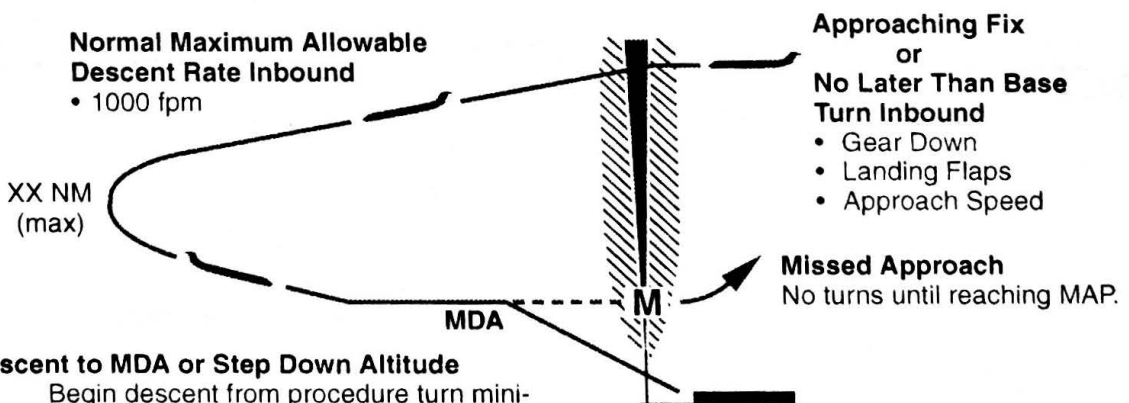

Descent to MDA or Step Down Altitude

- Begin descent from procedure turn minimum altitude when airplane established on in-bound track.
- Set Altitude Preselect Readout to rounded-up MDA to provide FGS level-off guidance

Approaching Fix or No Later Than Base Turn Inbound

- Gear Down
- Landing Flaps
- Approach Speed

Missed Approach
No turns until reaching MAP.

Descent below MDA

Do not descend below MDA, unless requirements specified for descent below MDA are satisfied.

Non-Precision Approach – Crew Coordination Procedures

- Use of autopilot, autothrottles and autobrakes (if operative) is recommended.
- Flight director must be ON when GFMS / FMS is used for lateral guidance.
- Either pilot callout – “2500” if automated voice annunciations are inoperative.
- Captain callout:
 - “Final Approach Fix”
- Prior to FAF, APPR Light (Green) must illuminate when using GFMS for lateral guidance.
- On final approach segment, a callout will be made anytime any crewmember observes an UNABLE RNP or UNABLE APPROACH message or displacement greater than -
 - 2° on a VOR approach, or
 - 5° on an NDB approach, or
 - 1/3 dot (ADI) on an LOC approach, or
 - 1 dot course deviation on PFD or CDI for GFMS / FMS non-precision approaches, or
 - When the underlying ground based NAVAID indicates a course deviation described above.

NOTE

If UNABLE RNP or UNABLE APPROACH message displays, use other means of navigation, or abandon approach and execute a missed approach.

Pilot-Flying	Pilot-Monitoring
<p>Fly approach.</p> <ul style="list-style-type: none"> Establish final landing configuration and final approach speed by Final Approach Fix. Level airplane at or above step-down altitudes. If autopilot is engaged, use the ALT CAP feature to level at or above the MDA. If necessary, intervene with the Pitch Control Wheel to level at or above the MDA. 	<p>Monitor Approach.</p> <ul style="list-style-type: none"> Set Altitude Preselect Readout rounded-up MDA to provide FGS level-off at MDA. Pay particular attention to level-off at MDA (or step-down altitude). <p>Callouts:</p> <ul style="list-style-type: none"> "1000" AFL on barometric altimeter – <i>"Before Landing Checklist complete"</i> "500" AFL on barometric altimeter – Airspeed ± Approach Speed and Descent Rate "100 above" MDA (bug on barometric altimeter) or step-down altitude. This callout takes priority over any other standard altitude callout. "Minimums" (bug on barometric altimeter).
<p>Approaching MDA</p>	
<p>■ If required visual references to descend below MDA are satisfied:</p>	
<ul style="list-style-type: none"> Call out – <i>"Landing, set missed approach altitude"</i> Intercept a normal visual glidepath for landing. 	<ul style="list-style-type: none"> Set Altitude Preselect Readout to the Missed Approach Altitude. Direct primary attention to monitoring instruments. <p>Callouts:</p> <ul style="list-style-type: none"> "100" AGL on Radio Altimeter "50, 40, 30, 20 10" AGL on Radio Altimeter (if automated voice callouts are inoperative)
<p>At MDA</p>	
<p>When ALT HOLD annunciates:</p>	
<ul style="list-style-type: none"> Ensure level-off does not descend below the MDA. Captain calls out – <i>"Go-around"</i> Execute missed approach. 	<ul style="list-style-type: none"> Set Altitude Preselect Readout to Missed Approach Altitude. Call out – <i>"Missed Approach Point"</i>

Requirements to descend below MDA

American Airlines Policy

1. If the required visual references to descend below MDA are satisfied, intercept a normal glide path, disconnect the autopilot and land using a normal rate of descent for landing.
2. When the flight director or autopilot levels off at or near the MDA, set the Altitude Preselect Readout to the Missed Approach Altitude and execute a missed approach. Do not descend below the MDA.

CAUTION

If go-around is initiated prior to the Missed Approach Point (MAP), do not initiate any turns until reaching the MAP.

3. Required visual references to descend below MDA —
At least **one** of the following runway or runway lighting visual references for the intended runway is required to be distinctly visible and identifiable:
 - Threshold
 - Threshold markings
 - Threshold lights
 - Runway End Identifier Lights (REIL)
 - Visual Approach Slope Indicator
 - Touchdown zone or touchdown zone markings
 - Touchdown zone lights
 - Runway or runway markings
 - Runway lights

NOTE

The approach lighting system (including the sequenced flasher) is not a substitute for the runway or runway lighting and does not satisfy the requirement for descending below MDA.

4. Descent below MDA will not be commenced or continued unless the airplane is continuously in a position from which a descent to a landing on the intended runway can be made at a normal rate of descent using normal maneuvers, and where that descent rate will allow touchdown to occur within the touchdown zone of the runway of intended landing (FAR 121.651).
5. The flight visibility must not be less than the visibility prescribed in the standard instrument approach procedure being used (FAR 121.651).

If Go-Around Required (Prior to Touchdown)

An autopilot / autothrottle (if engaged) go-around is recommended. (If ground contact is made during an autopilot go-around, revert to manual control.)

Go-Around Procedure

Refer to All Engine Go-Around in this section.

CAT I ILS Approaches

Requirements for Making CAT I ILS Approaches

Visibility

- The minimum visibility for the approach is as shown in the minimums table on the approach plate for Category C airplanes.
- The lowest authorized visibility for CAT I approaches is –
1800 RVR (550m) or 1/2 mile

If approach based on transmissometer:

- Touchdown: Controlling (Mid-field may be substituted if Touchdown not available)
- Mid-field or Roll-out: Advisory

Wind

- Tailwind: Max 10 kts (may be further limited by Performance section requirements)

With less than 4000 RVR (1200m) or 3/4 mile

- Crosswind: Max 15 kts

Weight

With less than 4000 RVR (1200m) or 3/4 mile

- Landing weight based on wet runway limits

Minimum Airplane Equipment to Begin an ILS Approach

With RVR 2400 (750m) or Better and a DH of 250 or Higher

- ILS Raw Data.

With RVR Less Than 2400 (750m) or with a DH of Less Than 250

- Autopilot ILS Mode or Captain's FD Display – FD Switch and FD CMD Selector may be in any position.
- ILS Receivers – Captain's required. **TWA** RADIO / NAV Switch may be in any position.
- Engines – Both required for a coupled approach.
- Autopilot Pitch Trim – Must be operative for a coupled approach.
- Vertical Gyros – Two required, VERT GYRO Selector may be in any position.
- **TWA** AHRS equipped – Two required (in NORMAL or BASIC Mode).
- **TWA** IRS equipped – Two required (IRUs may be in NAV or ATT Mode)
- AP Warning Light – One required.
- DFGC and its associated FMA – One required.
- Radio Altimeters and its associated DH Light – One required, autopilot used must be same system as operative Radio Altimeter.

35.2 APPROACH – LANDING – GO-AROUND

10-17-07

- CADC – One required if autothrottle to be used, CADC Selector may be in any position.
- EFIS Symbol Generators (EFIS airplanes) – One required, EFIS Selector may be in any position.
- EFIS Display Units (EFIS airplanes) – Three required, pilot-flying the approach must have both EFIS displays operating.
- Autopilot Disconnect – If autopilot used, capability to disconnect autopilot with Autopilot REL Button or Control Wheel Trim Switches on control wheel.

CAT I ILS Approach Profile

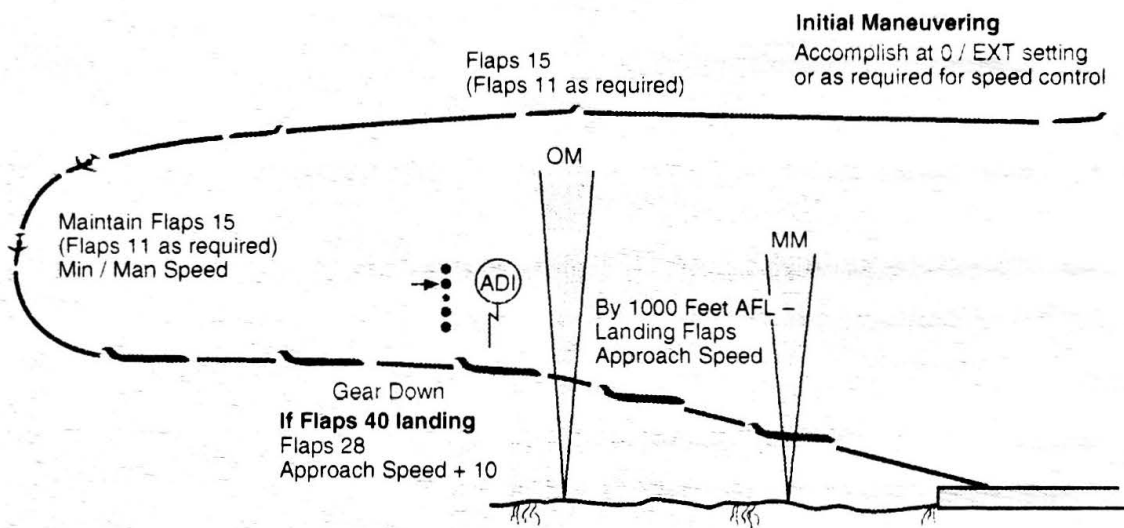

CAT I ILS Approach – Crew Coordination Procedures

- Use of autopilot and autothrottle (if operative) is recommended with less than 4000 RVR.
- Either pilot callout – “2500” if automated voice annunciations are inoperative.
- Captain callouts:
 - “Track – Track”
 - “Outer Marker” and MSL crossing altitude
 - “Auto Go – Auto Land” (if applicable)

Pilot-Flying	Pilot-Monitoring
Fly approach	Monitor Approach
	Callouts: <ul style="list-style-type: none"> • “1000” AFL on barometric altimeter – “Before Landing checklist complete,” after checking that all items on Mechanical Checklist are completed. • “500” AFL on barometric altimeter – Airspeed ± Approach Speed and Descent Rate.
At 100 Ft above DA (on Baro Altimeter)	
When advised that visual references are in sight: Confirm requirements to descend below DA are satisfied. ■ If requirements to descend below DA are satisfied: <ul style="list-style-type: none"> • Call out – “Landing” • Complete approach and landing. 	Callouts: <ul style="list-style-type: none"> • “100 above” • Visual references when in sight.
	Direct primary attention to monitoring instruments.
At DA (on the Baro Altimeter)	
■ If requirements to descend below DA are not satisfied: <ul style="list-style-type: none"> • Call out – “Go Around” • Execute a missed approach. 	Call out – “Minimums”
	Callouts: <ul style="list-style-type: none"> • “100” AGL on Radio Altimeter • “50, 40, 30, 20, 10” AGL on Radio Altimeter (if automated voice callouts are inoperative).

Requirements to continue Approach below DA / DH (FAR 121.651)

- Airplane must be continuously in a position from which a descent to a landing on the intended runway can be made at a normal rate of descent using normal maneuvers, and where that descent rate will allow touchdown to occur within touchdown zone of the runway of intended landing.
- Flight visibility must not be less than the visibility prescribed in the standard instrument approach procedure being used.
- Except for Category II or Category III approaches where any necessary visual reference requirements are specified by authorization of the Administrator, at least one of the following visual references for the intended runway is distinctly visible and identifiable to the pilot:
 - Approach light system, except that the pilot may not descend below 100 feet above the touchdown zone elevation using the approach lights as a reference unless the red terminating bars or the red side row bars are also distinctly visible and identifiable.
 - Threshold
 - Threshold markings
 - Threshold lights
 - Runway End Identifier Lights (REIL)
 - Visual Approach Slope Indicator (VASI)
 - Touchdown zone or touchdown zone markings
 - Touchdown zone lights
 - Runway or runway markings
 - Runway lights

If Go-Around Required (Prior to Touchdown)

An autopilot / autothrottle (if engaged) go-around is recommended. (If ground contact is made during an autopilot go-around, revert to manual control.)

Go-Around Procedure

Refer to All Engine Go-Around in this section.

CAT II / III Approaches

General

The Captain will fly the airplane throughout the approach and landing.
 For CAT II approaches, (1200 or 1600 RVR), an automatic landing is recommended.
 For CAT II approaches (1000 RVR), an automatic landing is required.
 For CAT III approaches, an automatic landing is required.
 Crew coordination procedures for CAT II and III are the same.

Decision Height (DH)

- A DH identified by an RA is specified on the approach plate for CAT II approaches and is 50 feet RA for CAT III approaches.
- If sufficient visual references for a successful landing are not established by DH and not maintained after DH, a go-around is required.
- Sufficient visual reference for a CAT II approach is the Category II Lighting System and for a CAT III approach is the Touchdown Zone or the Touchdown Zone Lights.

CAT II

- May be flown to an RVR as low as 1000, 1200 or 1600, as published.
- RVR 1000 requires an AUTOLAND.
- RVR 1200 or 1600, a coupled approach down to DH is required (AUTOLAND is recommended).
- Has a DH specified on the approach plate.

CAT III

- May be flown to an RVR as low as 600.
- Requires a DH of 50 feet.
- Requires AUTOLAND.

CAT II / III Summary

The following table summarizes the requirements for different RVRs.

To Go as Low as RVR	Your Minimum Required LMP	Your Lowest Approach Category Would Be
1600 / 1200 (500 / 350 m)	ILS (CAT II ONLY)	CAT II with DH
1000 (300m)	AUTOLAND	CAT II with DH
600 (175 m)	AUTOLAND	CAT III with 50' DH

Requirements for Making CAT II Approaches

Decision Height

- Published RA

Visibility

- The minimum visibility for the approach is specified below:

1600 RVR (500 m)

Requires one reporting transmissometer:

- Touchdown: Controlling

1200 RVR (350 m) or 1000 RVR (300m)

Requires two reporting transmissometers:

- Touchdown: Controlling

- Mid-field or Roll-out: One must be operational but is advisory (except in Canada where Mid-field must be reporting 600 RVR or better)

Wind

- Headwind: Max 25 kts (autoland only)
- Tailwind: Max 10 kts (may be further limited by Performance section requirements.)
- Crosswind: Max 15 kts

Weight

- Landing weight based on wet runway limits.

Runway

- CAT II or CAT III Runway with a DH identified by a RA.
- Minimum TCH of 35 feet required for autoland.

NOTE

If autoland on a CAT II runway, runway must have a localizer that is usable inside runway threshold.

Lighting

- Approach: ALSF I or II (sequenced flashing lights not required outside the U.S.)
- Edge: HIRL
- Runway and Markings: Centerline and Touchdown Zone Lights

Autobrakes

- Armed, if operative.

Requirements for Making CAT III Approaches

Decision Height

- 50 feet RA.

Visibility

- The minimum visibility for the approach is:

600 RVR (175 m)

Requires three reporting transmissometers:

- Touchdown: Controlling
- Mid-field: Controlling
- Roll-out: Must be operational but is advisory

Wind

- Headwind: Max 25 kts
- Tailwind: Max 10 kts (may be further limited by Performance section requirements.)
- Crosswind: Max 15 kts

Weight

- Landing weight based on wet runway limits.

Runway

- CAT III Runway with a minimum TCH of 35 feet.

Lighting

- Approach: ALSF I or II
(sequenced flashing lights not required.)
- Edge: HIRL
- Runway and Markings: Centerline and Touchdown Zone Lights
Precision Runway Markings or All Weather
Markings.

Autobrakes

- Armed, if operative.

Autoland

- Autoland required.

Equipment Requirements – CAT II / III

Equipment	ILS Mode CAT II	AUTOLAND CAT II / CAT III
Flight Directors	Both (Selector may be in any position)	
ILS Receivers	Both (Tuned to same frequency) (TWA RADIO / NAV Switch must be in NORM)	
Flaps / Slats	28 / LAND or 40 / LAND	
Autopilot Pitch Trim	Required	
Vertical Gyros	Two (Selector may be in any position)	
TWA AHRS Equipped	Two	
TWA IRS Equipped	Two (IRUs may be in NAV or ATT Mode)	Two (IRUs must be in NAV Mode)
AP Warning Light	One	
DFGC and associated FMA	One	
Radio Altimeters and associated DH Light	Both	
EFIS Symbol Generators (Honeywell EFIS airplanes)	Both (Selector must be in NORM)	
EFIS Display Units (Honeywell or SDS 2000 EFIS airplanes)	Four	
Autopilot Disconnect	Capability to disconnect autopilot with Autopilot REL Button or Control Wheel Trim Switches on control wheel	
LMP	ILS (CAT II ONLY)	AUTOLAND
Autopilot Systems	One – ILS mode	One – AUTOLAND mode
Autothrottle	N/R	Req'd
Autothrottle / Disconnect Switches	N/R	Req'd
Auto Ground Spoilers	N/R	Req'd
Engines	Both required throughout approach	Both required down to 50 feet (RA)
CADC	One if autothrottles used (CADC Selector in any position)	Both
Hyd Sys	N/A	Both pressurized *
Elec Sys	N/A	Normal **
CAWS	N/A	Req'd
RUDDER CONTROL MANUAL Light	N/A	Extinguished
Manual Flight Controls	N/A	No abnormal condition

N/R – Not required

N/A – Not applicable

* AUX pump may be used as a substitute for R eng pump.

Trans pump cannot be used as a substitute for either engine pump.

** APU generator may be used in lieu of one engine generator.

CAT II / III - Crew Coordination Procedures

Captain (PF)	First Officer (PM)
<ul style="list-style-type: none"> • Follow through on controls and monitor autopilot control of airplane and autothrottle control of airspeed. • For CAT II, coupled approach down to DH is required (autoland recommended). • Standard callouts and – <ul style="list-style-type: none"> – “Track – Track” – “Outer Marker” and MSL crossing altitude – “Auto Go – Auto Land” (as applicable) 	<ul style="list-style-type: none"> • Guard controls. • Monitor approach and remain on instruments throughout approach, landing, and rollout. • Standard callouts.
<p>While descending to 300 feet (RA): Check that the tracking performance for a successful landing are satisfied. Satisfactory tracking performance is defined as speed within ± 5 knots of Approach Speed, Localizer tracking within 1/3 dot, and Glide Slope tracking within 1/2 dot.</p>	
<p>At 300 feet (RA)</p>	
<ul style="list-style-type: none"> ■ If tracking performance requirements are satisfied: Include outside visual references as part of scan. ■ If tracking performance requirements are not satisfied or become unsatisfactory below 300 feet: Call out – “Go-around” and execute missed approach. 	<p>Call out – “300” RA</p> <ul style="list-style-type: none"> ■ If tracking performance requirements become unsatisfactory below 300 feet: Call out – “Go-Around”
<p>At 200 feet (RA)</p>	
	<p>Call out – “200” RA</p>
<p>At 100 feet (RA)</p>	
	<p>Call out – “100” RA</p>





At DH	
<ul style="list-style-type: none"> ■ If the required visual reference for a successful landing is satisfied: Call out – “Landing” ■ If the required visual reference for a successful landing is not satisfied or subsequently lost: Call out – “Go-around” and execute missed approach. 	<p>Call out – “Minimums”</p>
ROLL OUT	
<p>Monitor runway centerline lights to assure runway alignment.</p>	<p>Monitor Rising Runway until airplane slows to taxi speed.</p>
<ul style="list-style-type: none"> • Normally, the autopilot should remain engaged until rollout is complete. • Either pilot noting that the airplane is not tracking the Localizer call out – “Centerline,” and the Captain will disconnect the autopilot and manually control the airplane. 	
<p>At the point during rollout where only 3000 feet of available runway remain (as indicated by alternating red and white centerline lights), if the airplane has not yet decelerated to below 80 knots, apply maximum braking.</p>	

Conditions Requiring a Go-Around from a CAT II / III Approach

- Below 300 feet (RA), if satisfactory tracking performance is not maintained.
- The following are conditions requiring a go-around from a CAT II / III approach that may not be dictated by crew coordination procedures:
 - Failure of required airplane or ground equipment prior to DH (CAT II) or prior to touchdown (CAT III).
 - Autothrottle disengages (autoland only).
 - Captain determines that a landing cannot be safely accomplished within the touchdown zone.

If Go-Around Required

Accomplish autopilot / autothrottle (if engaged) go-around. If ground contact is made during an autopilot go-around, revert to manual control.

Go-Around Procedure

Refer to – All Engine Go-Around in this section.

Landing

Pilot-Flying	Pilot-Monitoring
<p>Spoiler Lever CHECK FULL AFT</p> <p>Both pilots will check for spoiler deployment. If Spoiler Lever does not move back to full aft (EXT) position, the Captain, regardless of which pilot is making the landing, will manually deploy spoilers.</p> <p>When spoilers deploy:</p> <ul style="list-style-type: none"> • PM will call out – <i>“Deployed.”</i> <p>If spoilers do not deploy (or fail to remain deployed):</p> <ul style="list-style-type: none"> • PM will call out – <i>“No spoilers,”</i> and • Captain will manually deploy spoilers. 	
<p>Reverse Levers AS REQUIRED</p> <p>The (PF) normally operates the Reverse Levers. If either engine fails to enter reverse, i.e., Reverse Lever does not move into reverse range, use caution in applying reverse on remaining engine.</p> <p>If either blue ENG REVERSE THRUST Light does not illuminate, the PM will call out – <i>“Left or right engine not in reverse.”</i></p> <p>If reverse thrust exceeds 1.3 EPR, PM will call out – <i>“1.3 EPR.”</i></p> <p>The PM will also call out airspeed of " '100 knots,' '80 knots,' and '60 knots.' "</p>	
<p>Auto Brakes AS REQUIRED</p> <p>The PM will call out – <i>“Auto brakes off”</i> if ABS DISARM Light or the AUTO BRAKE FAIL Light illuminates during landing roll.</p> <p>If using Auto Brakes on a dry runway, normally revert to manual braking at a safe speed below 100 knots, depending on deceleration rate and runway remaining. If runway is wet or slippery, continue auto braking until reaching taxi speed. Release auto braking by gently applying manual braking.</p>	

Maximum Wind Limits – Landing

General

- The following is a consolidation of all wind limits for landing (AFM and company policy).
- All wind limits include gusts.
- Except in an emergency, landings are not authorized whenever peak wind values exceed 50 knots.
- Wind limits may be further restricted by Emergency and Abnormal Procedures, Restricted Captain's Exemption 5549 (FM Part I, Section 10), or less than normal runway width as specified on Airport Ops Ad page.

Tailwind (AFM)

Tailwind 10 kts
 May be further limited by performance requirements.

Crosswind Component

If more than one condition applies, observe the most restrictive.

Runway (AA Policy)

Max Demonstrated 30 kts
 Braking Action Fair 20 kts
 Braking Action Poor 10 kts
 Braking action must be determined by ATIS, PIREPS, tower reports or environmental conditions including wet runway, standing water, slush, snow or ice.

Visibility

Less than 3/4 mile (RVR4000)..... 15 kts
 May be further limited by runway limits specified above.

Autoland

Headwind..... 25 kts
 Tailwind 10 kts
 Crosswind Component 15 kts
 May be further limited by runway limits specified above.

Flight Controls

The pilot-monitoring will guard the flight controls on all landings.

Auto Spoiler Operation

- Throttles must be at idle for automatic deployment of ground spoilers.
- Immediately on touchdown, PM will verify Spoiler Lever full aft and call out – “Deployed.” If the Spoiler Lever has not moved aft, the PM will call out – “No spoilers” and the Captain will deploy the spoilers manually.

WARNING

After reverse thrust is initiated, a full stop landing must be made.

Reversing

- When nosewheel is on the ground, the PF will select idle reverse and apply slight forward pressure on the yoke.
- With spoilers deployed and directional control assured, reverse thrust may be left at idle or increased to a target of approximately 1.3 EPR.
- Reverse thrust of more than 1.3 EPR should not be used unless stopping distance is in doubt.
- If reverse thrust exceeds 1.3 EPR, PM will call out – “1.3 EPR.”
- Do not remain in reverse thrust if directional control cannot be maintained and do not use asymmetrical reverse thrust to regain directional control.

CAUTION

Moving the Reverse Levers to reverse idle prior to the nose gear being firmly on the runway may cause the reverse buckets to contact the ground.

At 80 knots, start reducing reverse thrust so as to be out of reverse thrust by 60 knots (unless a longer reverse cycle is needed to assure safe stopping).

CAUTION

The combination of forward airplane movement and reverse thrust at airspeeds below 60 knots results in an airflow capable of causing ingestion of runway / taxiway debris into the engines. This condition should be avoided whenever possible.

When using more than idle reverse thrust, rapid movement of the reverse levers to the stowed position will cause the airplane to accelerate as the engines are decelerating to idle RPM.

Manual Braking

If stopping distance is critical, or other abnormal conditions exist, brakes may be used from touchdown to stopping.

To obtain optimum results from the anti-skid system, the following procedure is recommended:

- Apply and hold steady brake pedal pressure as needed for desired stopping distance.
- Do not release brake pedal pressure until the airplane speed has been reduced to a safe taxi speed.
- If brakes are released, release them fully; re-apply them early when approaching the runway turnoff point and hold steady brake pedal pressure until the desired speed is achieved.

In case of suspected brake failure, turn the anti-skid system off, but beware of hydroplaning or glare ice conditions which could lead to the misinterpretation that brakes have failed.

Landing - Supplemental Information

Glide Slope or VASI

The glide slope or VASI should be used, if available, on VFR approaches to help determine proper approach path. The noise problem is not confined to takeoff paths, it is also important to consider this problem during landing approaches.

Thrust Control During Approach

Autothrottle Use During Approach

To minimize large and abrupt Throttle movements when using the autothrottles, anticipate the changes in thrust and manually advance or retard the Throttles as required. Keep one hand on Throttles and be prepared to override or disconnect the autothrottle if the need arises.

A clutch mechanism permits manual positioning of either Throttle without disengaging the autothrottle. However, throttles should not be manually positioned except when in "CLMP" mode or, during descent, when the autothrottle FMA annunciates "LOW LIM". Overriding the autothrottle may cause excessive clutch wear requiring extensive down time to replace the autothrottle servo drive assembly.

Engine Spool-Up Time

The JT8D engine normally requires about eight seconds for acceleration from idle to Go-Around EPR. There are, however, many variables which can affect this time and cause one engine to be considerably different than another. Such variables are engine bleed, idle trim setting, pressure altitude, bleed valve scheduling and fuel control condition.

During Final Approach

The Throttles must be thought of as a primary flight control and used in coordination with the elevators to control airspeed, rate of descent, and position on glide path. Keeping one hand on the Throttles will result in an almost automatic reaction to requirements for small thrust changes. However, be particularly alert to the development of an abnormally high sink rate. If necessary, rapidly apply whatever thrust is needed to offset the high sink rate.

Normal Glide Path

The normal glide path is based on an instrument type approach. Once the final approach is established, only small adjustments to the glide path, approach speed, and trim need normally be made. This results in the same type of approach under IFR or VFR conditions.

Aim all approaches at the 1000 foot point on the runway. Although the actual touchdown point will vary with the flight-path angle, the touchdown will not be short or unnecessarily long if the recommended 1000 foot visual aim-point is used. If it appears that touchdown will be within the first 500 feet of the runway, re-adjust the glide path by positive application of thrust. Pulling back on the yoke without positive thrust application forces the main gear down and creates exposure to short landings or a tail strike.

The glide path angle as well as height when crossing the end of the runway affect landing distance. For example: crossing the end of the runway at 100 feet rather than 50 feet can increase landing distance by about 950 feet on a three degree glide path. Even crossing the end of the runway at a 50 foot height, the landing distance is increased as approach path becomes flatter; a flight path glide angle of one degree can increase landing distance by about 1500 feet over that required for a three degree path. Best results will be obtained at a normal ILS or VASI glide path angle.

Landing Flaps

A smoother, quieter approach and conservation of fuel can be accomplished using flaps 28 for landing. Flaps 40 may be required for landing due to runway length and / or conditions (refer to Before Landing – Autobrakes this section) or the Performance section. Additionally, the Captain may elect to use flaps 40 for landing when he deems the selection prudent. Examples of when the use of flaps 40 may be prudent are:

- Airplane is very light making speed reduction difficult
- Approach is steeper than normal due to ATC requirements
- When engine and airfoil anti-ice are on, which requires higher than normal engine thrust.

In the interest of fuel conservation, the approach should be planned to delay extending slats and flaps until as late as is practical. The final flap selection should be made prior to 1000 feet AFL. Approach should be stabilized by 1000 feet AFL if IFR or 500 feet AFL if VFR.

Use of Flaps 28 Versus Flaps 40

Factors favoring flaps 28:

- Consumes less fuel
- Lower power settings
- Less wear on flap tracks
- Quieter approach

Factors favoring flaps 40:

- Potentially less float in the flare
- Final approach airspeed easier to maintain
- Slower VREF - reduces landing roll slightly and may reduce brake wear
- Maintain proficiency for short field landing

Visual Approach

It is important to establish the proper flight-path angle. A flight-path angle of three degrees is recommended. The following variables affect the ability to accurately judge this angle:

- Runway Slope – An up-slope in either the runway or approach zone creates an illusion of being high. A down-slope in the runway or approach zone creates an illusion of being low.
- Visibility – Rain, haze, smoke, dust, glare, or darkness may create the illusion of being high.
- Runway Lighting – Bright runway lights appear closer, while dim runway lights appear farther away.
- Runway Dimensions – The width of the runway relative to its length will also affect visual perspective.

These illusions and their effects can be minimized by use of cockpit instrumentation and by awareness of the special problems associated with such approaches.

Final Approach

A three degree flight path can be closely approximated by maintaining 300 feet of altitude for each mile from the runway. For example, when crossing a fix five miles from touchdown, the airplane should be at (or slightly above) 1500 feet above the runway at that point. Any fix (e.g., DME) that is accurately defined can be used in applying this rule.

In addition to the 300-foot / mile rule, pitch attitude, rate of descent, and / or EPR can be used along with visual cues to insure a correct approach path.

The rate of descent on a three degree glide slope is a function of ground speed and will most often be between 650 and 800 feet per minute. If the ground speed can be estimated, the approximate rate of descent on a three degree glide path can be calculated by the following rule of thumb to give a three degree glide path: One-half the ground speed (knots) times 10 will give a close approximation of the descent rate (fpm) required.

Example

$$GS = 140; 140 \div 2 \times 10 = 700 \text{ fpm}$$

A too-flat approach is indicated by an increase in EPR required and a lower than normal rate of descent.

Pitch attitude is also a valuable clue. If the proper speed is maintained, the pitch attitude on final approach using flaps 28 will be approximately three degrees to 4.5° nose up (two degrees to 3.5° using flaps 40). If a higher pitch attitude is required, the approach is too flat.

Main Gear Threshold Crossing Height when Following the ILS Glide Slope

If ILS is available, it should be used whenever it provides adequate threshold clearance height, regardless of weather conditions. A wheel height crossing altitude of 20 feet has been established as a minimum for autopilot coupled approaches. When manually flown ILS approaches are made, the same or greater wheel height over threshold will result.

NOTES

- Where a displaced threshold is used for obstruction clearance the glide slope threshold crossing height (TCH) is at the displaced threshold.
- A glide slope TCH of less than 35 feet will produce less than the desired minimum wheel crossing height over the threshold. In such cases, a one to two dot displacement above the glide slope should be maintained from an altitude of 200 to 300 feet until flaring the airplane.

The ILS crossing heights are based on maintaining the glide path in a stabilized pitch attitude with no windshear. Windshear, a momentary increase in pitch attitude, and ILS beam characteristics can result in threshold crossing heights lower than those listed.

Under no circumstances should a "duck-under" maneuver be executed. The tendency to "duck-under" the glide slope in the latter stages of the approach can be obviously dangerous.

General Management of the Approach

The diagrams on the following pages portray the desired approach envelope for all VFR and IFR approaches. It illustrates that if not in a stabilized approach at the normal decision point (middle marker) with speed, sink rate, etc. stabilized, you are not prepared for a normal landing. Adjustments should be completed early in the approach. The descent rate should be limited to less than 2000 ft / min below 2000 feet AFL and 1000 ft / min below 1000 feet AFL. In the terminal area, speed brakes or speed brakes and slats are the preferred configuration for expediting a descent. If this configuration does not produce the desired rate, retract the speed brakes and extend flaps and / or gear as needed.

For Category I ILS installations, a transition from the ILS glide slope to a visual glide slope should be made between decision height (DH) and 100 feet. A visual aim point approximately 1000 feet down the runway will provide a touchdown point approximately 800 to 1500 feet down the runway.

The Radio Altimeter is biased to accurately indicate the height of the lowest part of the main wheels above the terrain (if the terrain is relatively flat). Therefore, the Radio Altimeter is very valuable as an aid in determining wheel height, and the pilot-monitoring should make all the radio altitude callouts on final approach to touchdown as indicated on the Standard Callouts profile (refer to Standard Callouts – All Descents, Approaches and Landings in this section). This wheel height information along with visual cues will give the pilot-flying a good assessment of the final stages of the approach, flare, and landing.

On visual approaches over flat terrain the 1000 foot crossbar should be passing out of view when the radio altitude has decreased to approximately 300 feet. The view of the threshold should be disappearing under the nose when the radio altitude has decreased to approximately 100 feet. It is important that your seat be correctly positioned to get the proper visual reference. (Refer to seat adjustment in Vol II – Miscellaneous).

Approach and Landing Geometry

ILS Approach - Flaps 28

Estimated Touchdown Point (No Flare) Assuming G/S Transmitter at 1000 ft.

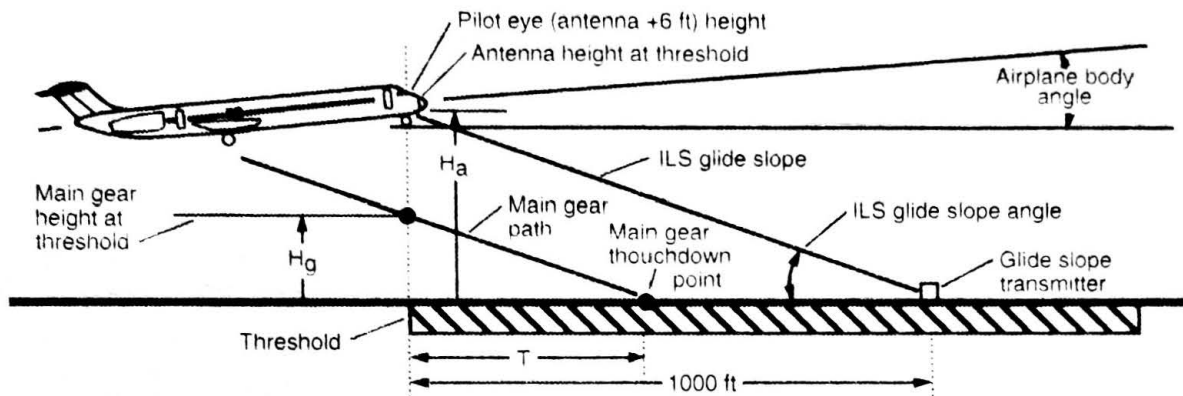

Glide path angle (degrees)	Estimated body angle (degrees)	Antenna height, H_a , at threshold (feet)	Main gear height, H_g , at threshold (feet)	Main gear touch-down point, T (feet)
2.5	4.9	44	29	664
2.75	4.65	48	34	708
3.0	4.4	52	39	744

Visual Approach - Flaps 28

Estimated Touchdown Point (No Flare) Assuming an Aim Point of 1000 ft.

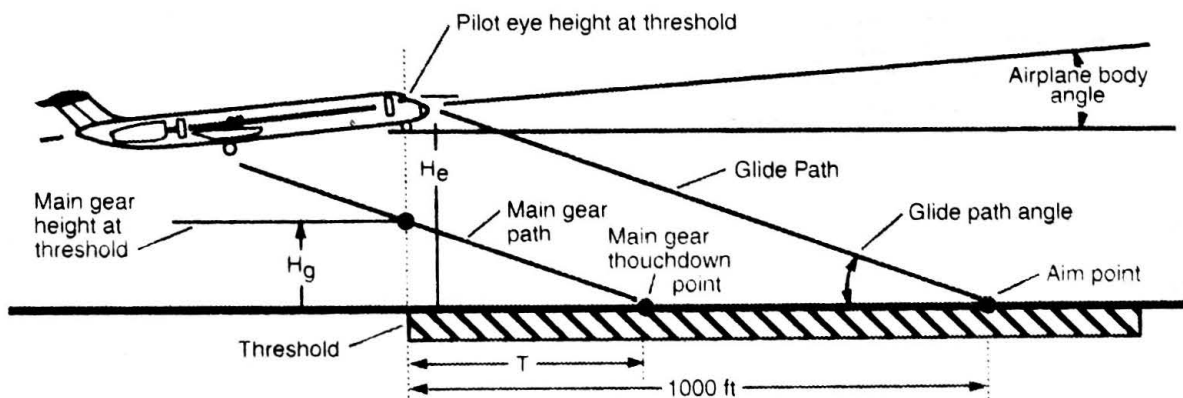

Glide path angle (degrees)	Estimated body angle (degrees)	Antenna height, H_e , at threshold (feet)	Main gear height, H_g , at threshold (feet)	Main gear touch-down point, T (feet)
2.5	4.9	44	24	550
2.75	4.65	48	28	583
3.0	4.4	52	32	610

ILS Approach - Flaps 40

Estimated Touchdown Point (No Flare) Assuming G/S Transmitter at 1000 ft

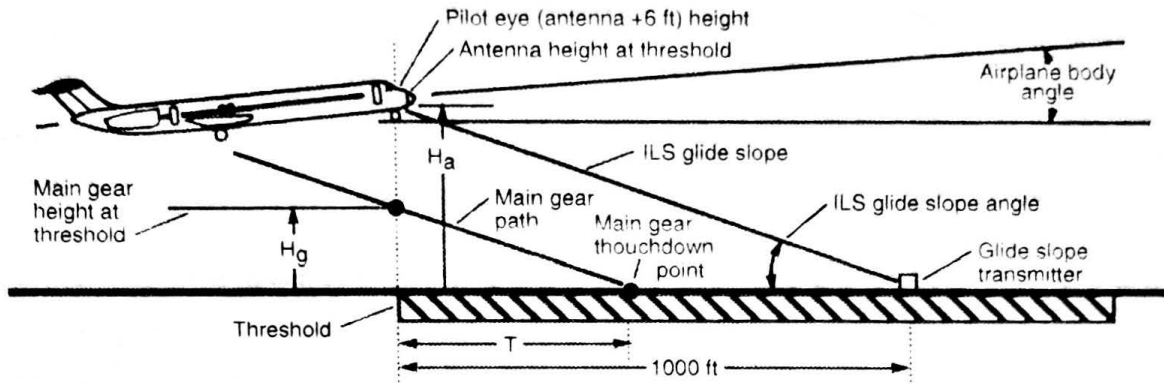

Glide path angle (degrees)	Estimated body angle (degrees)	Antenna height, H_a , at threshold (feet)	Main gear height, H_g , at threshold (feet)	Main gear touchdown point, T (feet)
2.5	3.2	44	28	649
2.75	2.95	48	33	681
3.0	2.7	52	37	708

Visual Approach - Flaps 40

Estimated Touchdown Point (No Flare) Assuming an Aim Point of 1000 ft

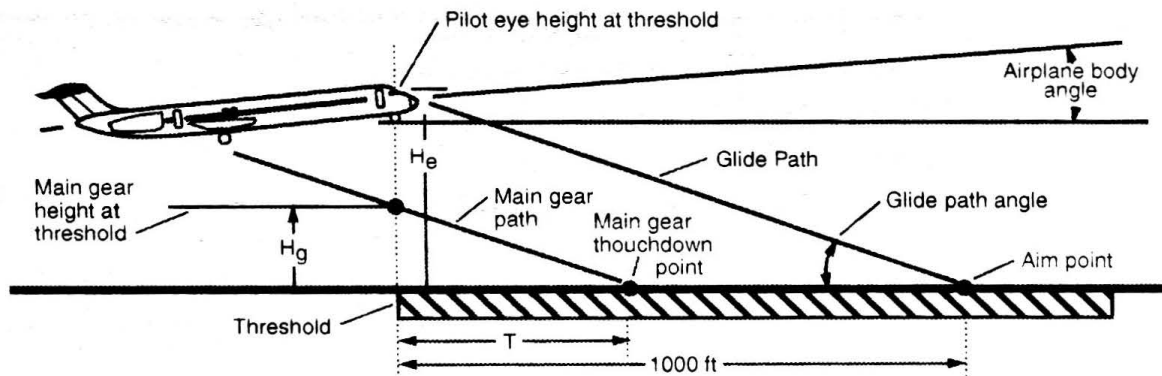

Glide path angle (degrees)	Estimated body angle (degrees)	Antenna height, H_e , at threshold (feet)	Main gear height, H_g , at threshold (feet)	Main gear touchdown point, T (feet)
2.5	3.2	44	22	503
2.75	2.95	48	27	562
3.0	2.7	52	31	591

Visual Ground Segments - Landing Approach - Flaps 28

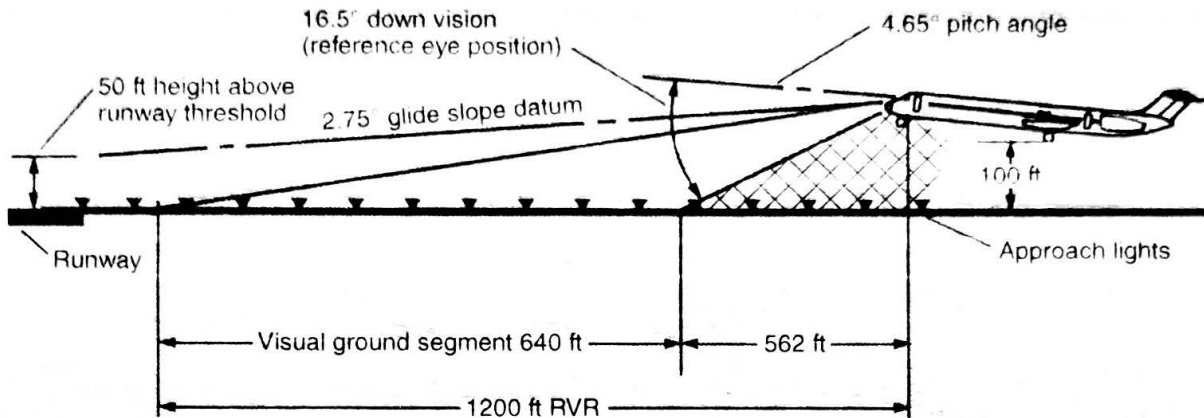

NOTE

With 16.5° down vision the pilot will, at 100 ft have visual reference of six or seven approach lights.

Visual Ground Segments - Landing Approach - Flaps 40

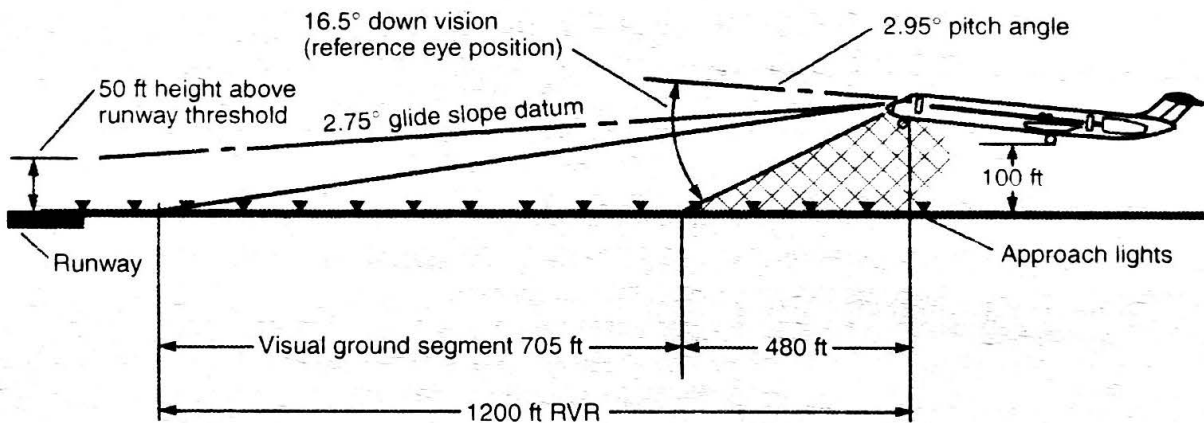

NOTE

With 16.5° down vision the pilot will, at 100 ft have visual reference of six or seven approach lights.

Pilot Eye Orientation with Ground

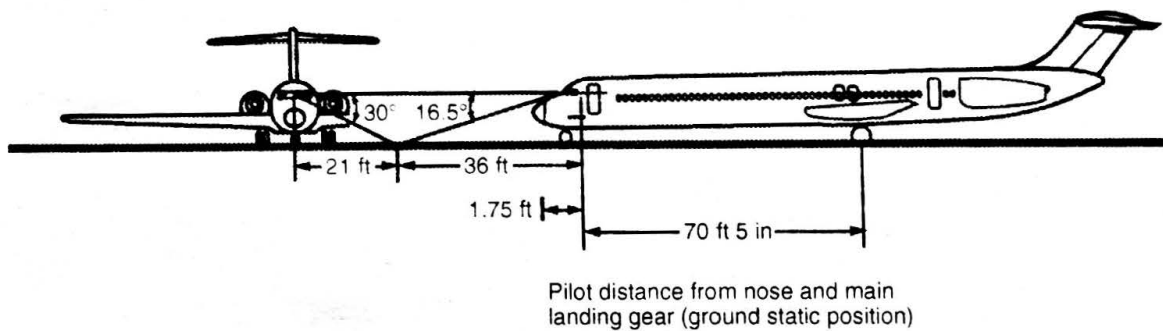
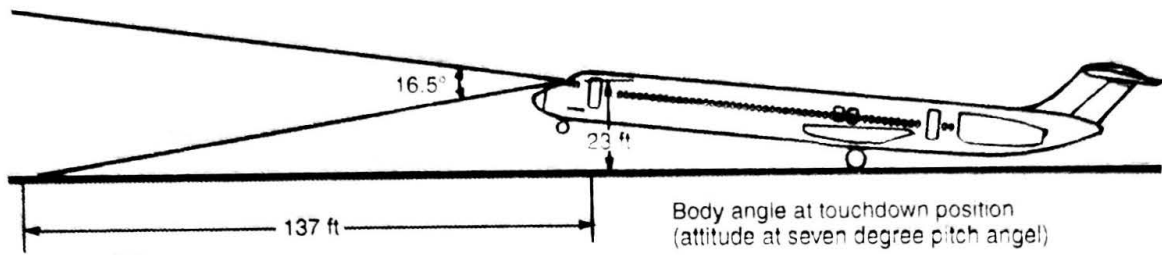

Summary

- The use of proper procedures will result in consistently safe and satisfactory approaches and will preclude short landings.
- Use the ILS whenever it provides adequate threshold clearance height, regardless of weather conditions.
- The VASI may be used realizing the characteristics and limitations of this system.
- If neither an ILS glide slope nor a VASI is available on a visual approach, apply the 300-foot / mile rule, the ground speed method, or any other available clues to ensure approach along a three degree flight path angle.
- A glide slope threshold crossing height (TCH) of less than 35 feet will produce less than the minimum 20 foot wheel crossing height over the threshold. If the TCH is less than 35 feet, abandon the glide slope at DH and fly the airplane visually to touchdown. Observe the 20 foot minimum wheel crossing height over the threshold. An aiming point slightly short of the 1000 foot point will produce a touchdown at the 1000 foot point.

50.10 APPROACH – LANDING – GO-AROUND

10-17-07

DC-9 Operating Manual **AA**

Over flat terrain the Radio Altimeter gives a very accurate indication of wheel height and should be used as an aid when approaching the threshold and thereafter until touchdown.

If the threshold is still readily visible over the nose at 100 feet radio altitude over flat terrain, it is a positive indication that the airplane is too low.

Landing

Speed Brakes

Since the automatic brake system is inhibited until the spoilers are deployed (automatically or manually) during landing, monitor the automatic deployment of the spoilers after touchdown. If the spoilers do not deploy automatically the Captain must manually deploy them.

Touchdown

Early stabilization of airspeed, thrust, and descent rate are essential to a good landing. For normal landing configuration, the descent rate will be 650 to 800 feet per minute. To prevent landing with brakes inadvertently applied, keep feet low on rudder pedals during landing.

The recommended landing procedure calls for reducing the sink rate at approximately 20 feet radio altitude. Only a two to three degree attitude change is required to reduce (but not stop) the rate of descent. As this attitude is being held, thrust should be slowly reduced. No attempt should be made to hold the airplane off by further increases in attitude. Thrust should be reduced to idle at or just before touchdown. With proper airspeed control and thrust management, touchdown will occur at no less than VREF.

The airplane tends to float in ground effect if flare control and thrust are excessive at touchdown. Floating before touchdown "eats up" runway rapidly. If speed is excessive, it's still better to set it onto the runway as near the 1000 foot point as possible, rather than allowing it to float to bleed off speed. Deceleration on the runway is about three times greater than in the air. For example, with 10 knots excess speed, floating and touching down on speed will use up about three to four times as much additional runway as would be required if the airplane were set down on the runway at the desired point and the speed bled off on the ground. Holding the airplane off for speed below reference before touchdown similarly increases landing distance.

On touchdown, it is important to lower the nosewheel to the runway and hold forward pressure on the control column. When this is done, the wing angle of attack is decreased, resulting in minimum lift, placing more weight on the main gear sooner; this not only increases rolling friction but increases braking effectiveness as well. This procedure is five times more effective in decelerating the airplane than that achieved from holding the nosewheel off in an attempt to use "aerodynamic" braking.

Tail dragging can result from excessive pitch angles caused by flying below reference airspeeds on final, attempting to obtain a smooth touchdown by holding the airplane off the runway and holding the nosewheel off in an attempt to achieve "aerodynamic" braking. The tail cone will contact the runway at a 10.5° pitch with the main landing gear struts compressed.

Bounced Landing Recovery Technique

A bounced landing occurs following approaches made at higher than normal rates of descent with excessive or late rotation.

Bounced landings can also occur because higher than idle power is maintained through initial touchdown, disabling automatic speedbrake deployment even when the speedbrakes are armed.

If the aircraft should bounce, hold or re-establish a normal landing attitude and add thrust as necessary to control the rate of descent. Avoid rapid pitch rates in establishing a normal landing attitude.

CAUTION

Tail strikes or nosewheel structural damage can occur if large forward or aft control column movements are made prior to touchdown.

When a bounced landing occurs, consider initiating a go-around by use of normal go-around procedures. Do not retract the landing gear until a positive rate of climb has been established because a second touchdown may occur during the go-around.

Directional Control

General

- Differential braking is effective for directional control when used with light-to-moderate braking depending on runway surface conditions.
- The nose gear steering wheel should not be used until ready to turn off the runway.

Reverse Thrust

- The application of reverse thrust tends to blank out the rudder. The effectiveness of the rudder starts decreasing with the application of reverse thrust and at 90 knots, at 1.6 EPR (in reverse) it is almost completely ineffective.
- Do not exceed 1.3 EPR reverse thrust on a wet or contaminated runway, except in an emergency when max reverse thrust may be used.
- If the airplane starts drifting across the runway while reversing, immediately return the reverse thrust levers to idle reverse to assist in regaining directional control and to restore rudder effectiveness.
- If the drift is not stopped by returning the reverse thrust levers to idle reverse thrust, come out of reverse and use idle forward thrust to regain tire cornering.
- Do not use asymmetrical reverse thrust to regain directional control.
- Reapply reverse thrust when directional control is restored.

Use of Reverse Thrust on Landing

- Immediately on touchdown, PM will verify Spoiler Lever full aft and call out – “*Deployed.*” If the Spoiler Lever has not moved aft, the PM will call out – “*No spoilers*” and the Captain will deploy the spoilers manually.
- When nosewheel is on the ground, the PF will select idle reverse and apply slight forward pressure on the yoke.
- With spoilers deployed and directional control assured, reverse thrust may be left at idle or increased to a target of approximately 1.3 EPR.
- Reverse thrust of more than 1.3 EPR should not be used unless stopping distance is in doubt.
- If reverse thrust of more than 1.3 EPR is exceeded, PM will call out – “*1.3 EPR.*”
- Do not remain in reverse thrust if directional control cannot be maintained and do not use asymmetrical reverse thrust to regain directional control.

Autobrakes

If installed / operative, must be armed prior to landing when any of the following conditions exist:

- Runway length less than 7000 feet
- RVR less than 4000 or visibility less than 3/4 mile
- Runway contaminated with standing water, snow, slush, or ice
- Braking conditions reported less than good.

In addition, the use of autobrakes is recommended when landing with gusty winds or crosswinds.

Autobrake settings should be appropriate to the conditions: MAX must be used when minimum stopping distance is required.

After landing, intervene with manual braking as necessary to slow the airplane at the desired rate.

When landing with flaps less than 26, use manual braking since the ABS will disarm upon wheel spin-up.

Getting the Most from the Brakes

Brake life and performance are affected by both the amount and rate of energy input. Wheel brakes absorb the energy of motion and convert it to heat. The higher the speed of the airplane at brake application the greater the heat the brakes must absorb for a given change of speed of the airplane.

The energy absorbed is cumulative to the extent that measurable time is required to dissipate heat. This energy of motion is called kinetic energy and is mass (airplane weight / g) times the square of the velocity. Kinetic energy of a landing airplane is measured in millions of foot-pounds and must be completely dissipated by the time the airplane stops at the gate.

This vast amount of energy is absorbed during landing by getting the nose gear on the runway and deploying spoilers, reversing thrust, and finally, using the brakes. The effectiveness of earlier actions will reduce the requirement for wheel brakes to absorb the remaining energy. Spoiler deployment and thrust reversing are most effective at higher speeds while brakes are most effective at lower speeds. Using brakes only at lower speeds, when practical, will improve brake life and result in better overall performance.

Good pilot technique (a stabilized approach and landing on speed) can increase the safety factor as well as improve total brake / landing maintenance related costs. During normal landings as speed is being reduced, the brakes should be applied just prior to the termination of reverse thrust operation.

Brake wear, due to heat buildup, also can increase rapidly during taxi and can have other adverse effects as well. Brake energy absorption is cumulative without a lengthy cooling time, so brake heat builds up during taxi. Always keep engines at minimum thrust during taxi. Initial thrust to overcome inertia and "get rolling" should be kept to the minimum possible and reduced as soon as possible. Braking technique should be intermittent, firm applications, with as much cooling time between applications as conditions permit.

Plan ahead. Minimize braking in turns by using the largest turning radius that circumstances will permit. This not only helps to keep brakes cool, but it provides the added benefits of reducing stress on the main trucks and keeps tire scrubbing to a minimum.

Be aware of local conditions. If speed is high during a landing roll, you should know whether you can extend your roll-out to a far turn-off, or whether an earlier turn-off will be necessary.

Landing Under Adverse Weather Conditions

General

This section discusses those techniques that apply to varying degrees of adverse landing conditions, from the everyday crosswind landing to the more complex problems of tire hydroplaning and slippery runways.

Don't try to offset a poor runway braking condition by landing short. While it is important not to land long, landing short can have more serious consequences than overrunning the far end of the runway at low speed. The desired touch-down point is still about 1000 feet from the approach end of the runway.

Brakes

The braking force available from the tires is proportional to the area in contact with the runway, the force on the tires perpendicular to the runway, the brake coefficient, and friction between the tires and runway. The contact area normally changes little during the braking cycle. The coefficient of friction depends on the tire condition and runway surface (concrete, asphalt, dry, wet or icy). The perpendicular force comes from airplane weight and any downward aerodynamic force. Raising the speedbrakes spoils the lift of the wing at this high speed and places approximately 70% of the airplane weight on the wheels. This increases the effectiveness of the brakes, when required, during the high speed portion of the landing roll.

Apply enough forward pressure on the control column to ensure effective nosewheel steering. However, avoid applying too much forward pressure as this creates a lifting force on the tail which takes some weight off the main gear, reducing braking effectiveness by as much as 10%.

Manual Brake Stopping

The following recommended procedure for using manual braking will give the optimum braking for all runway conditions:

- For short or slippery runways, immediately after nose gear touchdown, use full brake pedal.
- For long runways, soon after nose gear touchdown, smoothly apply a constant brake pedal pressure for the desired braking.
- Do not attempt to modulate, pump or improve the braking by any other special techniques.
- Do not release the brake pedal pressure until the airplane speed has been reduced to a safe taxi speed.
- To reduce brake wear, on runways where stopping distance is not a factor, delay applying brakes until the airplane has slowed below 100 knots. Then, smoothly apply a constant brake pedal pressure for the desired braking.

The anti-skid system will stop the airplane for all runway conditions in a shorter distance than is possible with either anti-skid off or brake pedal modulation. The anti-skid system adapts pilot-applied brake pressure to runway conditions by sensing an impending skid condition and adjusting the brake pressure to each individual wheel for maximum braking effort. When brakes are applied on a slippery runway, several skid cycles will occur before the anti-skid system establishes the right amount of brake pressure for the most effective braking. If the pilot modulates the brake pedals, the anti-skid system is forced to readjust the brake pressure to re-establish optimum braking. During this readjustment time, braking efficiency is lost.

On extremely slippery runways at high speeds, the pilot is confronted with a rather gradual deceleration and may interpret the lack of an abrupt sensation of deceleration as a total anti-skid failure. The natural response might be to pump the brakes or turn off the anti-skid. Either action will degrade braking effectiveness.

The pilot's seat and rudder pedals should be adjusted so that it is possible to apply maximum braking with full rudder deflection.

During taxiing, the pilot's heels should be on the floor, sliding the feet up on the rudder pedal, only when required, to apply brakes to slow the taxi speed, or when maneuvering in close quarters on the parking ramp.

Automatic Brake System (ABS)

For landing, any one of three levels may be pre-selected (MAX, MED, MIN). MED and MIN provide set deceleration rates. At MAX setting, right hydraulic pressure is applied at 3000 psi regardless of deceleration rate. With MED or MIN selected, little or no wheel braking may occur until the airplane has slowed, since the ground spoilers and thrust reversers are most effective immediately after touchdown and may satisfy the autobrake deceleration logic.

On short or contaminated runways, wheel braking may be least effective at the end of the runway because of rubber deposits, snow or ice; the middle of the runway offers the best friction for wheel braking. On short or contaminated runways use MAX autobrakes or apply aggressive manual braking immediately after touchdown.

NOTE

The pilot-monitoring should be alert for illumination of the amber ABS Light (ABS disarmed) during the landing roll so that manual braking procedures can be initiated.

The MAX setting of the autobrake system requires a special technique on landing. Due to the very rapid deceleration that occurs in MAX mode, the nose gear should be lowered **immediately** after main gear touchdown to avoid abrupt and hard nose wheel runway contact. Use of MAX autobrakes is best suited for short or contaminated runways where stopping ability must be maximized.

The airplane speed at which the transition from autobrakes to manual braking is made varies with airplane deceleration and stopping requirements. For runway conditions that produce good deceleration, the transition from autobrakes to manual braking can be made at pilot discretion. However, when runway stopping distance is limited, or on a very contaminated runway, the transition to manual braking should be close to a safe taxi speed.

FOD - Reversing at Low Airspeeds

Using reverse thrust at low speeds on snow and ice covered runways can cause engine foreign object damage. It is a natural tendency to carry thrust reversing to a lower speed and use less brakes when the braking action is expected to be poor. However, runways which have been cleaned with snow removal equipment usually have chunks of ice and snow remaining and / or sand applied. Under these conditions, the engines are especially susceptible to blade damage. To minimize reingestion damage potential, the procedures for reverse thrust operations should be strictly followed unless airplane safety dictates otherwise.

Dry Runway - Crosswind

Keep the wings level during the approach. Maintain runway alignment by crabbing until approximately 100 feet, then use the forward slip maneuver for touchdown.

Since the ailerons are controlled by tabs, they tend to lose their effectiveness at slow speeds and high angles of attack. However, the spoilers are hydraulically controlled and are always operative. This makes roll control non-linear. The airplane has a very slow roll response for the first five degrees of yoke travel. This roll response increases rapidly as the yoke is rotated further and the spoilers deploy. This non-linear roll response can contribute to overcontrolling in roll during landing.

If the airplane drifts off the runway centerline during the final phase of the landing maneuver, attempting to correct back to the centerline increases the possibility of landing light / wing tip contact with the runway. If jet wash is encountered during the final phase of the landing maneuver, the combination of jet wash and nonlinear roll response also increases the possibility of landing light / wing tip contact with the runway. Depending upon the amount and rate of displacement, the Captain may decide that a go around is the more prudent course of action rather than attempting to correct back to the runway centerline.

Avoid holding the airplane off during landing; low angles of attack during landing provide positive lateral control. As seen from the following chart, increasing the pitch angle at touchdown reduces the maximum bank angle at which a landing light / wing tip will contact the runway.

Pitch and Bank Angle Effects

With the main landing gear compressed the landing light will strike the runway at approximately eight and one-half degrees of bank. Excessive bank angles should be avoided at low altitudes.

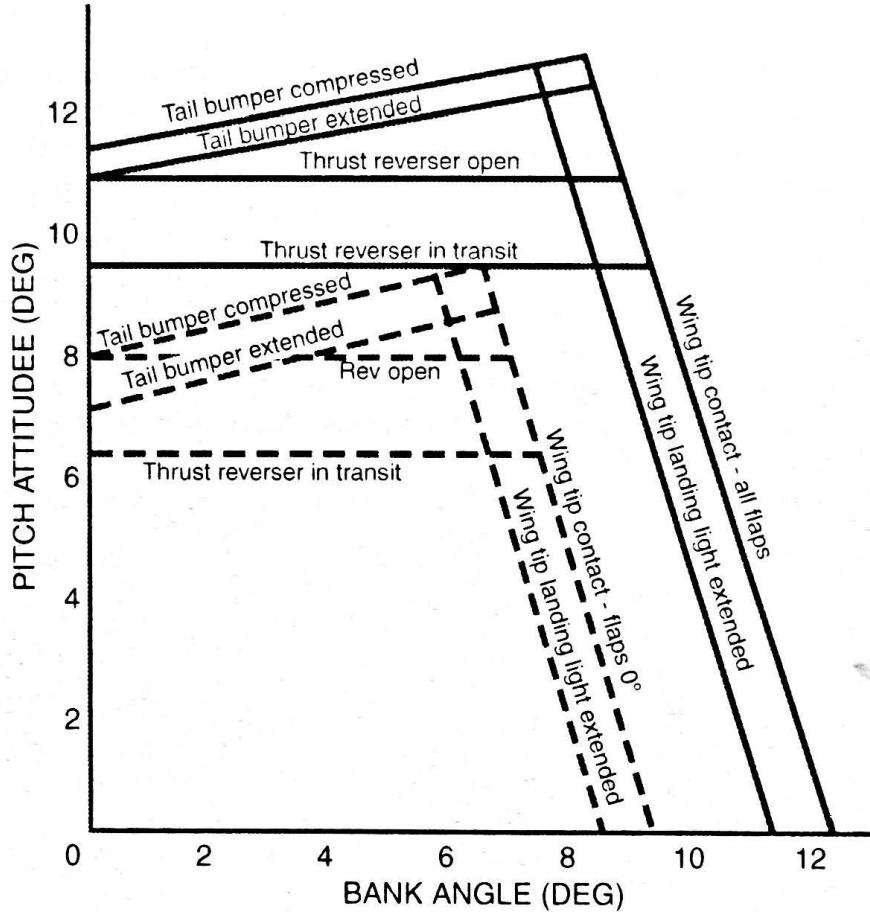

Bank Angle Limit Vs. Pitch Attitude

- Main Gear Struts Extended
- - - Main Gear Struts Compressed - Tires Flat

Slippery Runway - No Crosswind

Braking on a slippery runway can range from good to virtually nil. Snow-covered runways are at least twice as slippery as a dry runway. Ice-covered runways can be four to 16 times as slippery as dry runways, depending upon temperature. Ice near the melting point is the most slippery.

Standing water and slush on the runway can produce hydroplaning as well as low-speed slickness. Hydroplaning speed will frequently be less than the touchdown speed. The higher the speed, the greater the hydroplaning effect. Without reverse, hydroplaning can double or triple runway stopping distance.

At high speeds on slippery runways, reversing is the best aid in stopping. Using high levels of symmetrical reverse early in the landing roll will produce the greatest degree of stopping force. When coming out of reverse, do not rapidly go to forward idle thrust. This may aggravate the stopping problem. Directional control will be primarily through use of the rudder. At lower speeds, nosewheel steering and differential braking may provide directional control.

Slippery Runway - Crosswind

A slippery runway and crosswind make a bad combination. Plan touchdown on center line or slightly on the upwind side.

On touchdown, take positive action to lower nose gear to runway and maintain moderate forward pressure on control column to assist in directional control. Avoid excessive control column pressure and verify spoilers are deployed.

After touchdown airplane may weathervane into wind and drift towards downwind side of the runway.

Maintain directional control primarily with rudder pedals. Use differential braking as needed. Be alert for drift toward downwind side of runway. The rudder required in strong crosswinds may cause nose gear to turn to an angle which could induce skidding.

One of the worst situations occurs when there is a crosswind and sufficient water and speed to produce total tire hydroplaning. Reverse thrust tends to disrupt airflow across rudder and increases tendency of airplane to drift downwind, especially if a crab or yaw is present. Apply reverse thrust to idle reverse thrust detent. After reverse thrust is verified, gradually increase reverse thrust as required to no more than 1.3 EPR.

As reverse thrust increases above 1.3 EPR, rudder effectiveness decreases until it provides no control at about 1.6 EPR. Do not exceed 1.3 EPR reverse thrust on a wet or contaminated runway, except in an emergency when max reverse thrust may be used.

If weathervaning or moving to downwind side of runway, release brakes and reduce or stop reversing to regain control. Forward thrust can push airplane onto desired runway track even with little or no traction. Use of forward idle thrust must be tempered by runway remaining. However, do not come out of reverse at a high RPM. Sudden transition of reversers before engines spool down will cause a forward acceleration. Tires will regain traction as airplane slows below hydroplaning speed, thus improving directional control. **Do not** attempt to maintain directional control by using asymmetric reverse thrust.

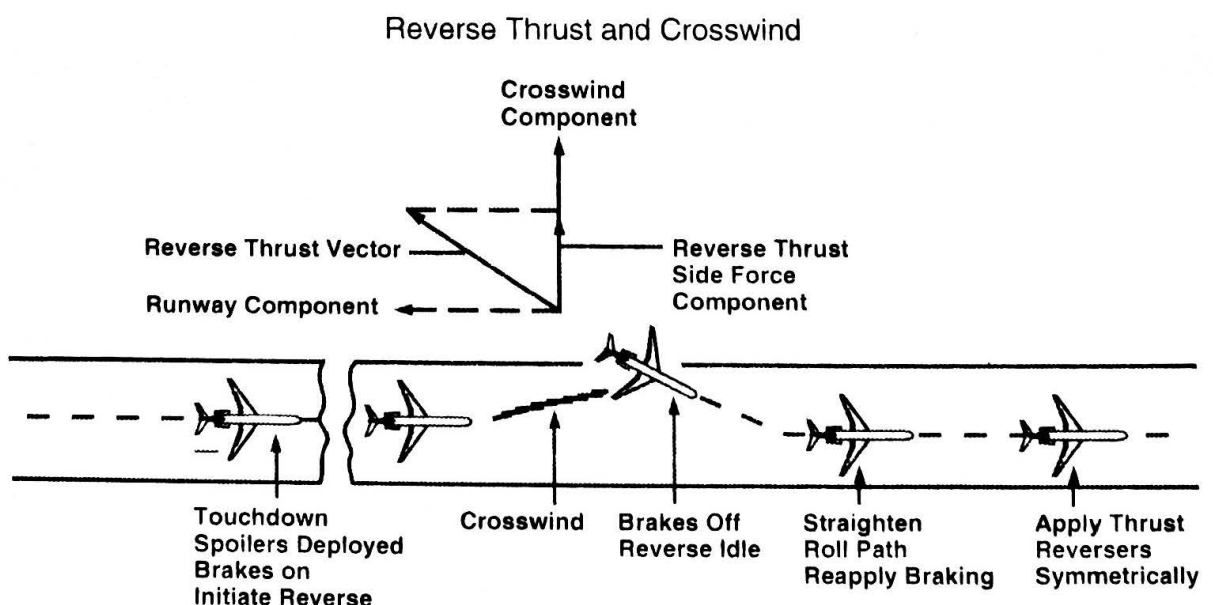

All Engine Go-Around**If Airborne****Thrust, Rotate and Flaps**

Simultaneously:

- TOGA
- Apply GA thrust
- Rotate – max pitch 20°
- Call out "Flaps 15" ("Flaps 11" as required).

Check FMA Mode Annunciators and V-Command Bar on PFD or ADI.

NOTES

- Autopilot remains engaged during go-around if making a coupled approach.
- If an engine failure occurs during go-around with the autopilot engaged, the DFGS provides an input to the rudder to offset asymmetric thrust.
- This input is removed whenever the autopilot is disengaged or when any other pitch mode (i.e., ALT HLD) is selected.
- If ground contact is made during an autopilot G/A, revert to manual control.

Gear

When positive rate of climb has been established, call – "Positive Rate – Gear Up," and give palm up hand signal.

Spoilers

Disarmed.

Speed

Maintain Approach Speed to 1000 feet AFL (not less than $V_{REF} + 5$).

Climb Out

Use normal takeoff profile procedures.

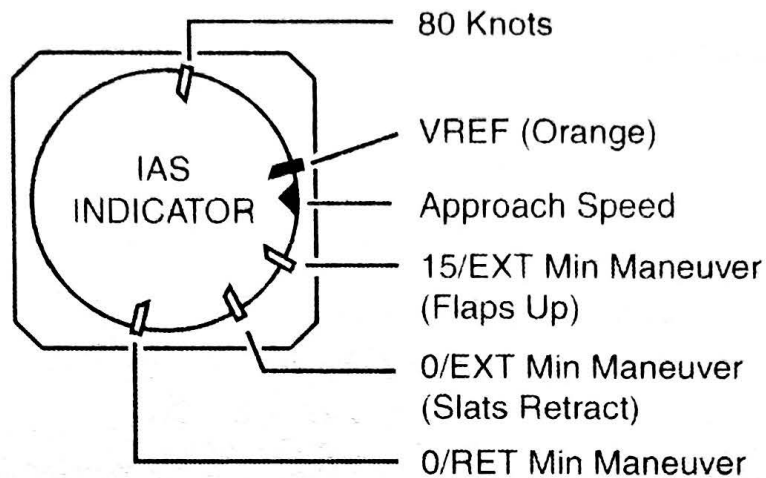
**NOTES**

- If more than 15° of bank is required for maneuvering, increase speed to 15 / EXT bug. Do not change configuration until at 0/EXT speed if 30° bank angle is required.
- The GFMS may command up to 27° bank angle (FMS up to 25°) with NAV selected. For this reason the pilot-flying must ensure that the aircraft is properly configured for the airspeed being flown prior to selecting NAV on the DFGC panel.

If on Runway

WARNING

After reverse thrust is initiated, a full stop landing must be made.

Autopilot & Auto-throttle

Disengage.

Flaps

Call out *"Flaps 15"* (*"Flaps 11"* as required).

Check

Spoilers – Retracted.

Stabilizer – Adjust as necessary.

Thrust

Advance Throttles toward GA thrust. Push TO / GA Buttons, check FMA and V-Command Bar on ADI. Check EPR's are increasing evenly.

Speed

Rotate – Use VREF Speed.

Initial climb – Use Approach Speed (VREF + 5 Minimum).

Gear

When positive rate of climb has been established, call – *"Positive Rate – Gear Up,"* and give palm up hand signal.

Spoilers

Disarmed.

Speed

Maintain approach speed to 1000 feet AFL (not less than $V_{REF} + 5$, max pitch 20°).

NOTES

- Expect the takeoff warning horn to sound as thrust is applied if the flaps have not yet reached the takeoff range or stabilizer does not agree with stabilizer computer.
- Pilot-flying should promptly apply go-around thrust unless both hands are needed to control the airplane. If necessary, have pilot-monitoring advance Throttles, using command – "*Go-Around Power*". Avoid use of statement – "*Takeoff Power*" as this could be interpreted to mean "Take the power off."

Climb Out

Use normal takeoff profile procedure.

Table of Contents

After Landing – Taxi

Preface 10.1
Expanded Checklist 10.1
Flaps with Snow / Ice / Slush 10.2
Use of Reverse Thrust During Taxi 10.2
One Engine Taxi 10.3
 General..... 10.3
 Restrictions..... 10.3
APU Usage 10.3
 Overnight Terminations 10.4

Parking

Preface 15.1
Expanded Checklist 15.1
Post-Flight Inspection..... 15.4
Oil Quantity Check 15.5
Use of Aft Stairs for Passenger Deplaning..... 15.5
Deplaning Passengers without a Jet Bridge..... 15.6

After Landing – Taxi

Preface

The After Landing – Taxi checklist will be accomplished as follows:

With the exception of the AUTOPILOT, AUTOTHROTTLE, and AUTO BRAKE (which are normal runway items) all other items of this checklist should not be accomplished until clear of runway.

The First Officer will check that all items have been accomplished. Any item that cannot be verified as having been accomplished will require a challenge and response.

When all items have been accomplished, First Officer will advise, – "After Landing – Taxi checklist complete."

Expanded Checklist

Captain	First Officer
LANDING LIGHTSRET Flood lights and wing / nacelle lights, if used, should be turned off when clearing the active runway.	
SPOILER LEVERRET	
	AUTO BRAKEOFF / DISARMED
	ENGINE IGNITION OFF
Command – "Flaps up."	On command: FLAPS / SLATS UP / RET, NO LIGHTS
CAUTION <i>When retracting the flaps and slats, leave the FLAP / SLAT Handle in the 0 / EXT position until the flaps are retracted, The FLAP / SLAT Handle may then be moved to the UP / RET. This delay will help prevent damage to the upper arm of the slat sequence mechanism crank. If the feedback force is overridden and the FLAP / SLAT Handle is moved to UP / RET before flaps are fully retracted, a metallic click sound may be heard when the flaps reach the retracted position.</i>	
	RADAR OFF





	<p>APU..... AS REQUIRED</p> <ul style="list-style-type: none"> • Allow 3 minutes after landing before starting APU. • See NOTES on APU Usage. <p>■ If the APU is required and does not start or is inoperative: Advise Operations / Maintenance APU is inoperative and left engine will be kept running until external power is established.</p>
<p>For one engine taxi, command right engine shut down.</p>	<p>PNEU X-FEEDS..... OPEN</p> <p>On command: RIGHT ENGINE (for one engine taxi) SHUT DOWN Engine may be shut down two minutes after landing.</p>
	<p>OVERWING HEATER SWITCH AS REQUIRED Normally, Overwing Heater Switch ARMED. If icy precipitation (snow, ice, frost, freezing rain, sleet, freezing fog, etc.) exists or is anticipated, or if the aircraft is to be de-iced, Overwing Heater Switch OFF.</p>

Flaps with Snow / Ice / Slush

Refer to GENERAL – Cold Weather Operations – Taxi-In and Parking.

Use of Reverse Thrust During Taxi

Reversers should normally not be used during taxi for stopping or slowing the airplane except in an emergency.

One Engine Taxi

General

To conserve fuel and reduce brake wear during taxi, one engine taxi should be used whenever practicable. Conditions permitting, one engine taxi may be accomplished **without** the APU.

If a delay is incurred before reaching the arrival gate, Captain should evaluate estimated hold time and when practicable both engines should be shutdown to conserve fuel.

Consider the following before one engine taxi without APU:

- All galleys and both overwing heaters automatically shed.
- AC Load limitation is 1.0. It may be necessary to turn off some non-essential electrical equipment to remain within limits.
- If cabin temperature becomes uncomfortable, start APU.

Restrictions

One engine taxi is not authorized when:

- Jet blast will be excessive.
- Ramps and taxiways are slippery.
- If significant precipitation (snow, sleet or freezing rain) is occurring that could adhere to or collect in the engine inlet, the engine inlet must be checked by Maintenance or authorized deicing personnel prior to restart.

APU Usage

Standard procedure is to shut down right engine regardless of gate support equipment availability. If APU is not required for air conditioning, one engine taxi **without** APU is authorized. After landing, allow a minimum of 3 minutes before initiating an APU Start. ?

The Changeover Report includes expanded information related to the availability of external power and pre-conditioned air (PCA) at the assigned gate. This information will be used to determine whether the APU should be started on taxi-in.

If the gate assignment on the Changeover Report (ACARS or voice) is not accompanied by any further information, **both** external power and PCA will be available at the gate.

10.4 AFTER LANDING – PARKING

10-17-07

If external power or PCA will not be available at the assigned gate, one of the following messages associated with the gate will be included on Changeover Report, and will be acted upon as follows:

Message	Action
NO EXT PWR	Start APU 2 mins prior to gate arrival.
NO EXT PWR / NO PCA	Start APU 2 mins prior to gate arrival.
NO PCA	APU may be started on taxi-in if, in the Captain's judgement, A/C packs would be required to heat or cool the airplane while at the gate.

NOTES

- It is recommended that PCA be used, when available, instead of the APU and A/C packs. This reduces the heat input into the tail compartment, as well as, fuel consumption and APU usage.
- Starting the APU for extended gate holds (with engines shut down) is still standard operating procedure regardless of gate support equipment availability.
- On through or turn-around flights with very short ground times or for other specific conditions (e.g., high surface winds), ground personnel may decide not to connect external power / PCA. In such cases, they will advise the crew by sending the NO EXT PWR / NO PCA message on Changeover Report.
- Starting the APU before 3 minutes has elapsed could cause residual hydraulic fluid to be ingested into the APU and cause smoke to enter the cabin.

Overnight Terminations

The APU will or will not be started on taxi in based on the policy outlined above. After all passengers have deplaned, it will be standard procedure for the cockpit crew to shut down the air conditioning packs and the APU if external power has been connected.

Parking

Preface

The items on the Parking checklist will be accomplished by the appropriate crewmember as indicated by the duty assignment column. This checklist is accomplished by challenge and response. The First Officer will read the challenge portion. The Captain will respond to all items ensuring accomplishment of all required checks and items. The First Officer will also respond to items identified by an (‡). When all required items have been accomplished, the First Officer will advise, – *"Parking checklist complete."*

Accomplish the first four items immediately upon gate arrival without challenge or response and without reference to the checklist, then accomplish entire checklist from the beginning using challenge and response.

Expanded Checklist

On flights with no crew change or when incoming crew is met by outgoing crew, check only boxed items.

Captain	First Officer
<p>BRAKESPARKED Brakes will remain parked at all times unless Guideman specifically requests release. If Overheat Light illuminated, refer to QRH – EMER / ABNORM – LAND.</p>	<p>Make F/A prepare for arrival PA just as airplane stops at gate.</p>
<p>SEAT BELTS SIGNSOFF</p>	<p>APU or EXTERNAL POWER ESTABLISHED</p> <p>On Captain's command: FUEL LEVERS OFF Place right FUEL Lever OFF. Check APU or external power is connected to the appropriate bus prior to placing left FUEL Lever OFF.</p>
<p>Both pilots should verify engine shutdown by decrease in N₁, EGT, N₂ and fuel flow.</p>	



15.2 AFTER LANDING – PARKING

10-17-07



	<p>ANTI-COLLISION / EXTERIOR LIGHTS OFF / AS REQUIRED</p> <p>Turn anti-collision lights off when last engine is shut down. Leave position lights on.</p>
<p>ENGINE IGNITION OFF</p>	
<p>FUEL PUMPS AS REQUIRED If APU operating, leave RIGHT AFT FUEL TANK PUMP Switch ON.</p>	
<p>EMERGENCY LIGHTS OFF Check that Aft Overhead Panel emergency flood lights are extinguished.</p>	
<p>PROBE HEAT OFF</p>	
<p>ANTI-ICE OFF</p> <ul style="list-style-type: none"> • AIR FOIL ANTI-ICE Switches – OFF • WINDSHIELD ANTI-ICE Switch – OFF • ENG ANTI-ICE Switches – OFF 	
	<p>AIR CONDITIONING .. AS REQUIRED</p>
	<p>OIL / HYD / O₂ QTY's CHECKED</p>
	<p>HYDRAULIC PUMPS HI / OFF</p> <ul style="list-style-type: none"> • ENG PUMP Switches – HI • TRANS and AUX PUMP Switches – OFF
<p>ARRIVAL REPORT, DELAY CODES, and APU HOURS UPDATED</p>	
<p>IRS's (if installed) OFF</p> <p style="text-align: center;">NOTE</p> <p>IRS battery may discharge if the IRS Mode Selector is not set to OFF prior to removing airplane power.</p>	
	<p>TRANSPONDER STBY Code selector – 1200</p>





LOG BOOK COMPLETED Make appropriate entries.	
FLIGHT DIRECTORS OFF	
O₂ REGULATOR SUPPLY LEVERS OFF ‡ All O ₂ REGULATOR SUPPLY Levers should be OFF.	
COCKPIT LIGHTS AS REQUIRED ‡ All cockpit lights including EFIS Displays should be off or dimmed at flight terminations, except for the floodlights. This minimizes heat build-up and reduces premature failure.	
Accomplish only on Overnight Terminations after All Passengers Have Deplaned	
GALLEY POWER OFF	
	VOLT / AMP INDICATOR SELECTOR AS REQUIRED Place in position other than BATT VOLT or BATT AMP.
	AIR CONDITIONING ...AS REQUIRED <ul style="list-style-type: none"> • Position AIR CONDITIONING SUPPLY Switches OFF unless advised by Ground Personnel to leave air conditioning system on. • If AIR CONDITIONING SUPPLY Switches are in the ON position, the outflow valve must be open.
	OUTFLOW VALVE AS REQUIRED Operate CABIN ALT CONTROL Wheel manually until OUTFLOW VALVE POSITION Indicator is opposite the FLAP / SLAT lettering on pedestal unless advised by Ground Personnel to leave air conditioning system on.
	RECIRCULATION FAN AS REQUIRED When station temperature is freezing or below, place AIR CONDITIONING RECIRCULATION FAN Switch in ON position.





	<p>APU..... AS REQUIRED If APU operating, leave operating unless advised by station personnel to shut down.</p>
	<p>BATTERY SWITCH AS REQUIRED • If APU operating – ON If external power in use – OFF</p>
	<p>GROUND SERVICE BUS..... AS REQUIRED • Leave airplane with only Ground Service Bus powered unless advised otherwise by station personnel. • When Recirculation Fan will be operated due to freezing temperature leave normal power established. Recirculation Fan is not powered by Ground Service Bus.</p>
	<p>O/W HTR SWITCH OFF</p>
<p>POST FLIGHT INSPECTION AS REQUIRED</p>	

Post-Flight Inspection

Airplanes requiring a Post-Flight Inspection are identified in the heading section of the Flight Plan / Release by an asterisk immediately following the destination airport. Airplanes terminating overnight at stations so designated shall receive a Post-Flight Inspection by a cockpit crewmember.

Report to the Ticket Lift Agent, Station Agent, or an AA Supervisor any mechanical discrepancy that requires corrective action prior to next flight.

This Post-Flight Inspection is not intended to be as detailed as the Pre-Flight Walk-Around Inspection; instead it is an accelerated walk-around to detect obvious discrepancies affecting fuselage, wing, empennage, engines, landing gear and tires that could cause a departure delay if not discovered prior to Pre-Flight for the next departure. If the airplane is moved after crewmembers have completed the Post-Flight Inspection, the station will be responsible for the condition of the airplane.

Oil Quantity Check

Station personnel normally do not check and service engine oil automatically, except at departure stations for extended overwater flights. To avoid first flight-of-the-day delays due to oil servicing, it is imperative that during each Parking checklist a crewmember determine the need for oil service.

- Request servicing for any engine that contains less than 10 quarts.
- If the aircraft is terminating and any oil quantity gage reads less than 14 quarts, notify maintenance and make a numbered entry in the aircraft logbook.

NOTE

Following engine shutdown, oil quantity indications will normally increase. The check of oil quantity should be made after indications stabilize.

Use of Aft Stairs for Passenger Deplaning

At some stations the aft stairs may be used for passenger deplaning. The following procedures apply when the aft stairs are used for this purpose:

- Crew will be notified on Change-Over Request of the intent to use the aft stairs for deplaning.

NOTE

Leave AUX HYD Pump ON after parking until AFT CABIN DOOR Light illuminates.

- Crew will inform number one Flight Attendant of the plan to use the aft passenger door.
- If it was planned to use the aft stairs for deplaning, but the aft stairs will not be used, the Captain will not move the SEAT BELTS Switch to the OFF position until the Flight Attendants and passengers have been informed with an appropriate PA announcement.
- When airplane is parked, engines shut down and anti-collision beacon is turned off, Agent will lower aft stairs. After stairs are down and in place, Agent will then proceed to the aft passenger door, knock on door to inform Flight Attendants that the door is going to be opened. The Agent will initiate and complete opening of the door. AFT CABIN DOOR Light illuminating is the signal to the cockpit that the stair operation is complete and the AUX HYD PUMP Switch may be positioned OFF.

NOTE

If Captain wishes to delay or cancel use of aft stairs, leave the anti-collision light on after engines are shut down, until such time intentions have been communicated to and understood by ground personnel.

Deplaning Passengers without a Jet Bridge

When not using a jet bridge (stand or stair in use) and passengers need to be deplaned, the left engine must not be running. The Captain will be requested (on interphone) to shut down left engine and to idle right engine. Captain should respond with – *"Shutting down left engine, right engine at idle."* Ground personnel will advise when deplaning is complete and boarding stand or stair is removed.



DC9 Operating Manual

BULLETIN

Subject: Electronic Flight Bag (EFB) Operations

No. DC-9-112

Date 11-12-07

File: Vol. I – Behind SYSTEMS Tab

General

On Nov 12, 2007, the DC9 fleet begins EFB operations.

The FAA has granted American Airlines Ops Spec approval for an Electronic Flight Bag (EFB) program using Class I hardware. Class I hardware is commercial off the shelf computer systems, portable and not attached to the aircraft (except for power needs).

The Class I EFB program allows volunteer participating flight crews to carry required flight manuals (as specified below) in digital format on their own personal computers instead of carrying paper manuals.

NOTE

Participation in the EFB program is optional and voluntary.

To participate, log-on to AAPilots.com and select "Electronic Flight Bag (EFB)" from the "Tools" box on the left side of the home page. Then select "Required Flight Manuals" on the Electronic Flight Bag page and follow the prompts.

EFB manual revisions will be posted on AAPilots.com website. The manuals may be downloaded from any internet connection to AAPilots.com.

NOTE

Check Airman, Tulsa Tech pilots, and Management pilots will not receive AAPilots.com manual update notification. Upon HI-6 notification of a manual update, download the updated manual from the fleet page of the Required Flight Manuals page.

Participating flight crews are required to view a short EFB training module prior to using EFB on a revenue flight. The module can be found on the Electronic Flight Bag area of the AAPilots.com website.

Manuals included in the Class I EFB program are:

- Flight Manual Part One (use cockpit door code for password)
- Operating Manual Volume I
- Performance section from Volume I
- Operating Manual Volume II
- MEL / CDL / PDL.

Distribution: List 621 and all DC9 Captains and F/Os

Manuals not included are:

- Jeppesen Charts
- QRH.

Flight crews participating in this program may provide comments and feedback via the "Line Pilot Feedback" form on AAPilots.com.

EFB Hardware Specification

EFB hardware must meet the following requirements:

- A "commercially available, off the shelf" technology, laptop, or tablet computer, model year 2004 or newer.
- Minimum of 512MB of installed RAM (1GB recommended).
- At least one main processor with a minimum processor speed of 1Ghz (Intel laptop) or 700MHz (Intel Tablet PC), or 667MHz (PowerPC).
- Minimum of 20GB hard drive or dedicated hard drive partition installed.
- Small "handheld devices" such as, but not limited to "Palm Pilots" are not acceptable for flight deck use as an EFB.

EFB Operating System Specification

The following operating systems are approved for use:

- Apple System Ten, OS X 10.3.9 "Panther", plus updates
thru
- Apple System Ten, OS X 10.4.9 "Tiger" Universal and PPC, plus updates
- Apple System Ten, OS X 10.5.0 and 10.5.1 "Lepoard"
- Microsoft "Windows 2000" (including Office, Home, and Pro Editions)
- Microsoft "Windows XP, Home Edition / Media Center Edition"
- Microsoft "Windows XP, Professional Edition"
- Microsoft "Windows XP, Tablet PC Edition".
- Microsoft "Windows Vista, Home, Business, Ultimate, and Tablet Editions".

NOTES

- Microsoft operating systems must have all current updates.
- The operating system may not be based on the "Palm Operating System" or "Microsoft Windows CE Operating System".

EFB Required Software

Since the flight crew's use of EFBs on the flight deck is limited in scope to "read only required flight manual reference data", there are only two software requirements:

- Adobe Acrobat Reader
- Internet browser software capable of securely connecting to AAPilots.com.

Restrictions for EFB Use on Flight Deck

- EFBs must have all communications devices turned off for the entire time the unit is "in use" on the flight deck while in-flight. This includes, all current and future wireless communications technology.
- Turn off / remove any remote antennas that might be connected to the EFB and do not activate any software which would "call" or "use" any antenna.
- External and internal GPS antennas that connect to EFBs are prohibited from use at any time on the flight deck while the aircraft is in flight.
- EFBs should be brought to the flight deck with their internal battery fully charged. Batteries that do not meet the manufacturers spec for "general use" should be replaced.
- EFBs should have "virus protection" turned on and updated prior to downloading digital manuals from AAPilots.com.
- Crewmembers shall insure the hardware aspect of the EFB is kept up to date. Batteries, hard drives, circuit boards, and video screens all have experienced recalls by various manufacturers at various times. It is the responsibility of the flight crewmember to insure hardware is in compliance with all manufacturer updates / recalls / revisions.
- Crewmembers are required to have the "approved" version of required software "installed and functional".
- Crewmembers are required to have the current revision of digital manuals downloaded prior to the beginning of the sequence flown. (Same as paper manual revisions). Pilots will be notified of revisions via 1) HI6 message system and 2) AAPilots.com.

Phase of Flight Use

Parked at the Gate – All flight crewmembers can use EFB, unrestricted.

Taxi – All EFBs must be stowed and turned off (sleep / hibernate acceptable), unless aircraft is stopped on the taxiway or holding area with the parking brake set. Then only one EFB may be used.

Takeoff to 10,000 feet – All EFBs stowed.

Above 10,000 feet to Cruise – PM may use EFB.

Cruise – PM may use EFB.

Descent – PM may use above 10,000'.

Terminal – If in holding pattern, and reference information is required for "safety of flight", PM may use just as they would use paper manuals, or call dispatch. Otherwise, below 10,000' EFBs must be stowed (sleep / hibernate acceptable).

Approach – All EFBs stowed.

Landing – All EFBs stowed.

Taxi In – All EFBs stowed, unless aircraft is stopped on the taxiway or holding area with the parking brake set, then only one EFB may be used.

Parked at the gate – All flight crewmembers can use EFB, unrestricted.

When PM is using an EFB on the flight deck, the PF is required to monitor flight instruments for any deviations that could be caused by radio magnetic interference from the EFB. If such interference is discovered, the crew shall: 1) fly the aircraft, 2) note the condition, 3) turn off the EFB, and 4) fill out ASAP and P2 reports noting how the interference affected flight instruments.

Training Module

Participating pilots will be required to view a short EFB training module, which is available on AAPilots.com. The training module will consist of topics such as:

- Regulations for use of an EFB on the flight deck
- EFB hardware requirements
- EFB software requirements
- How to find the manual revisions and download it at AAPilots.com
- Proper downloading of data, importance of virus protection
- Checklist additions
- Proper monitoring of flight instrumentation during EFB use
- Maintenance of EFB, and requirements regarding such
- Password protection of data
- Battery failure / fire and overheat procedures.

Power Sources

A spare battery is required. Pilots are required to begin the trip with batteries fully charged.

Summary

Hopefully this EFB program will make your job easier, more efficient, and enhance the operation.

For the DC-9 Fleet Support Team
Captain R. David Johnson

Air

Pressurization Pre-Flight

System Selector Switch..... PRIMARY
 STDBY On and TRANSFER LOCKOUT Lights EXTINGUISHED

■ **If a light is illuminated:**

System Selector Switch..... STDBY then PRIMARY
 TRANSFER LOCKOUT Light.....PRESS

■ **If light remains illuminated:**

Refer to MEL.

LDG ALT DEPARTURE FIELD ELEVATION

LDG BARO.....CURRENT ALTIMETER SETTING (MSL)

RATE LIMIT Knob SET at INDEX MARK

Cabin Alt Control Lever AUTO (up)

TWA **Pressurization Pre-Flight**

System Selector Switch.....AUTO 1 or AUTO 2

Auto Inop Lights EXTINGUISHED

LDG ALT DEPARTURE FIELD ELEVATION

LDG BARO.....CURRENT ALTIMETER SETTING (MSL)

RATE LIMIT Knob SET at INDEX MARK

Pneumatic Crossfeed Valves and Pressure Gage

Pneumatic crossfeed valves, when closed, are designed to prevent flow of high pressure engine bleed air from entering crossfeed manifold. However, some air will enter crossfeed manifold because the valves will not stop 100% of air flow. Bypassing air may eventually build up in crossfeed manifold and pressure is indicated on the Pneu Press Gage. Therefore, Pneu Press Gage may indicate pressure with both crossfeed valves in the closed position. Observed pressure will vary depending on thrust setting / bleed air available. To determine if crossfeed valves are properly closing, the following may be accomplished during cruise:

- Ensure PNEU X-FEED VALVE Levers are in the CLOSED position.
- Position AIR FOIL Anti-ice Switches to ON.
- Observe PNEU PRESS Gage. Indicated pressure should decay to approximately zero.
- Position AIR FOIL Anti-ice Switches to OFF.
Observe PNEU PRESS Gage. If pressure does not decay to approximately zero or builds up above 22 psi within approximately 10 seconds, make an E6 entry at next point of landing.

Establishing Pneumatics

CABIN ALT Control Lever..... AUTO (up)
 Outflow Valve Position Indicator..... VALVE OPEN
 PNEU X-FEED Valve Levers..... OPEN
 APU Air Switch ON or AIR COND COLDER
 Observe PNEU PRESS Gage indicates in normal range.

NOTES

- If cabin temperature is below 75°F (25°C), position APU AIR Switch to ON.
- If cabin temperature is above 75°F (25°C), APU AIR Switch may be positioned to AIR COND COLDER.
- When APU air is used to supplement engine air, do not select AIR COND COLDER position. ON position provides best combination of air flow and refrigeration for this condition.

Air Conditioning on Ground, with or without Engines Running and Using APU Bleed Air

AIR CONDITIONING SUPPLY Switches (one at a time) AUTO

- Due to high electrical starting loads of the heat exchanger cooling fans, the air conditioning packs should be turned on one at a time.
- Observe associated Press Gage or Flow Gage indicates in normal range.

If Press Gage indicates approximately 12 psi or lower, the Flow Gage indicates approximately nine o'clock or lower, or if cabin / cockpit airflow is low, consideration should be given to turning off one pack. Turning off one pack may increase the amount of air delivered to the cabin / cockpit by the operating pack. The pack with lower supply pressure / flow should be turned off. If pack supply pressures / flows are approximately the same and are reading above 12 psi / nine o'clock, then selection of pack to be turned off is the discretion of the crewmember. If no improvement in cabin / cockpit airflow is apparent, try turning on shutdown pack and turning off operating pack.

AIR CONDITIONING RECIRCULATION FAN Switch AS DESIRED

AC LOAD Meter CHECK

When using the APU generator for electrical power, two air conditioning units operating may exceed 1.25 limit on the APU generator.

CKPT and CABIN TEMP Selectors..... AUTO (DOT)

AIR COND SHUTOFF Switch AUTO

RAM AIR Switch..... OFF

Ground Ventilation

NOTE

This procedure may be used to provide ventilation when pneumatics are not available. However, this procedure should not be used on warm days since high tail compartment temperatures will raise cabin temperatures to an uncomfortable level, in addition to diluting the effectiveness of pre-conditioned air (PCA) if connected.

CABIN ALT Control Lever AUTO (up)

Outflow Valve Position Indicator..... VALVE OPEN

RIGHT AIR CONDITIONING SUPPLY Switch..... AUTO or HP BLD OFF

RAM AIR Switch..... ON

Operation with Cabin or Cockpit Temp Selector in MANUAL

- When in MANUAL mode make adjustments in small increments and allow temperature to stabilize before making further adjustments.
- Avoid driving the temperature control valve to full HOT to prevent an overheat trip of the pack.
- When operating with the CABIN TEMP Selector in MANUAL, monitor the cabin supply temperature and do not allow it to exceed 150°F. If the pack output temperature exceeds 190°F (not indicated on gage) the pack will trip and some loss of pressurization may occur. When the temperature cools sufficiently, the pack will reinstate automatically. After the pack reinstates position the temperature control valve to mid range and resume normal operation.

Dispatch for Unpressurized Flight

Maximum altitude when airplane is dispatched for unpressurized flight is 10,000 feet.

CABIN ALT Control Lever MANUAL (down)

Outflow Valve Position Indicator..... VALVE OPEN

Check that outflow valve position indicator indicates VALVE OPEN. Outflow valve position indicator should remain in this position throughout flight.

Air Conditioning.....USE NORMAL PROCEDURES

NOTE

At altitudes above about 9500 feet cabin altitude warning horn and vocal warning may sound and CABIN ALT Light and MASTER WARNING Lights illuminate.

Manual Pressurization Control

Pre-Flight (Airplane First Flight of Day)

If dispatched using manual pressurization, check MANUAL operation of CABIN ALT Control Wheel and Outflow Valve Position Indicator; if all cabin doors are closed, turn off air conditioning if on; position CABIN ALT Control Lever to MANUAL (down); push in and rotate wheel to position Outflow Valve Position Indicator to VALVE CLOSED then VALVE OPEN; set air conditioning as required.

NOTE

Airplane must be unpressurized on the ground and for takeoff.

Before Takeoff

CABIN ALT Control Lever CHECK in MANUAL (down)

Outflow Valve Position Indicator..... CHECK VALVE OPEN

NOTE

The cabin versus airplane altitude schedule placard should be used as a guide to prevent exceeding max differential pressures which will activate the pressure relief valves.

Takeoff

Use normal takeoff procedures.

After Takeoff (as soon as practical)

Outflow Valve Position Indicator..... SET OPPOSITE
FLAP 40 INDEX

Climb (after airplane clean-up)

Outflow Valve Position Indicator SET OPPOSITE
FLAP 28 INDEX

Re-adjust to 300-500 ft / min cabin climb.

Do not engage PMS.

NOTES

- Throughout the flight, outflow valve positioning should be coordinated with throttle movement.
- Hold Cabin Alt Control Wheel firmly when adjusting, as it will tend to move toward close at a varying force depending on cabin differential pressure and indicated airspeed.
- Disconnect autothrottles for any intermediate or final level off and use manual throttles with very slow inputs.

Cruise

When reaching cruise altitude:

Outflow Valve Position ADJUST

Adjust outflow valve to achieve a zero rate of climb.

After stabilized in cruise:

- Adjust outflow valve so as to achieve max of 7.5 PSID and zero rate.
- Do not use PMS or autothrottles if they hunt during cruise.

Descent

Use manual throttles during descent.

Outflow Valve Position ADJUST

Adjust outflow valve to achieve a 300-500 ft / min descent.

- Hold Cabin Alt Control Wheel firmly and be prepared to make adjustments during throttle movements.
- Reduce engine thrust slowly and rotate wheel towards VALVE CLOSED to compensate for bleed air reduction.
- Anticipate changes in cabin vertical speed when leveling off at intermediate altitudes.

When cabin altitude is approximately 3000 to 2000 feet above destination field elevation:

Outflow Valve Position ADJUST

Adjust outflow valve to achieve a zero rate of descent until airplane altitude equals cabin altitude.

When airplane altitude equals cabin altitude:

Outflow Valve Position Indicator VALVE OPEN

- Slowly move outflow valve position indicator to VALVE OPEN (if not at VALVE OPEN).
- Wheel and indicator should remain in this position for remainder of flight.

APU

APU Start - Ground / In Flight

WARNING

Do not start the APU during fueling operations. An explosion can occur.

NOTE

Before starting APU ensure RAM AIR and AIR CONDITIONING SUPPLY Switches are OFF.

- BATT SwitchON (locked)
- Fire Warning (if not previously accomplished)TEST
Refer to Fire Warning Test this section.
- APU DOORS SwitchAUTO
- APU AIR SwitchOFF
- APU FIRE CONT SwitchNORM

■ **If AC electrical power is not available:**

START PUMP Switch..... ON

■ **If AC electrical power is available:**

Fuel Boost Pumps AS REQUIRED

Normally, use right aft fuel boost pump for APU operation. At Captain's discretion, center tank fuel may be used for APU operation provided more than 1400 pounds of center tank fuel is available or APU operation monitored in cockpit.

APU MASTER Switch RUN

Position APU MASTER Switch to RUN and wait approximately 60 seconds before continuing start procedure.

This separates start faults associated with APU inlet door actuator from the APU itself.

APU MASTER Switch START / RELEASE

Momentarily move APU MASTER Switch to START and then release. A windmilling start is improbable if APU has been cold soaked for more than 30 minutes.

NOTES

- During start, ground and in flight, an APU may take up to approximately 55 seconds to reach operating RPM, after first indication of RPM. Do not mistake this increased time to reach idle as a hung start.
- Starter duty cycle begins with the first indication of RPM.
- Momentary deflection of the EGT and RPM Gages during start is normal.
- Electric start capabilities allow starts to 37,000 feet even after prolonged cold soaking.
- **TWA** Maximum electric starting altitude is 30,000 feet; maximum operating altitude is 35,000 feet.
- During windmill starts, there may be no RPM indications for over one minute, and a complete start may take in excess of two minutes.

APU OIL PRESS LOW Light EXTINGUISHED
Light should extinguish at or prior to 95% RPM.

NOTE

In flight, if initial start attempt unsuccessful, repeat start attempts as necessary. Probability of start increases at lower altitudes.

After APU running and electrical power established:

Fuel Boost Pumps AS REQUIRED

Normally, right aft fuel boost pump is used for APU operation. However, center tank fuel may be used for APU operation provided 1400 pounds of center tank fuel is available or APU operation monitored in cockpit.

START PUMP (if operating) OFF

APU AIR Switch (ground only) AS REQUIRED

Load control valve opens after APU has been operating for one minute.

PNEU PRESS Gage NORMAL

PNEU X-FEED VALVE Levers AS REQUIRED

APU Shutdown

WARNING

Do not shut down the APU during fueling operations. An explosion can occur.

- APU AIR SwitchOFF
- APU DOORS SwitchAUTO
- APU MASTER SwitchOFF

APU will shut down one minute after APU MASTER Switch placed to OFF.

■ **If APU does not shut down one minute after APU MASTER Switch positioned to OFF:**

- APU FIRE CONT SwitchOFF & AGENT ARM
- After APU shuts down, position APU FIRE CONT Switch to NORM.

CAUTION

The APU FIRE CONT Switch must be positioned to NORM to disarm the cockpit APU FIRE AGENT Switches.

NOTE

After SHUTDOWN in flight, APU may continue to windmill. Normal indications are 0% to 11%.

Autoflight

Autoland Pre-Flight Test

Both VHF Nav Radios SELECT NON-RECEIVABLE ILS FREQUENCY
 Both FD Switches..... FD
 NO AUTOLAND Light..... EXTINGUISHED

NOTE TWA (Aircraft with AHRS)

After the autoland pre-flight test, the AHRS system makes a self test. Check that the NO AUTOLAND Lights extinguish when test is complete.

■ **If NO AUTOLAND Light is illuminated:**

Check compass headings for agreement ($\pm 2^\circ$). After slewing compass, if compass headings agree and light is still illuminated, maintenance action is required before an Autoland Pre-Flight Test can be performed.

Autoland Button.....PRESS

Check that NO AUTOLAND Light flashes for approximately 50 seconds and then extinguishes.

DFGC 1-2 Switch SELECT OPPOSITE COMPUTER

Autoland Button.....PRESS

NOTE

The Autoland Pre-Flight Test must not be run simultaneously on both Flight Guidance Computers.

Electrical

Electrical System Pre-Flight

- CSD Disc Switches NORM (guarded) and SAFETIED
 The CSD Disconnect Switches should be safetied with copper breakaway wire.
- L and R GEN Switches RESET and ON
- AC BUS X TIE Switch AUTO
- DC BUS X TIE Switch OPEN

Battery Check

- During battery charging, when the battery state of charge is low, the battery ampere reading should be approximately a steady 40 amps that will decrease as the battery becomes fully charged.
- Verify that the battery is not discharging and that the battery voltage is within normal limits as follows:
 - Place Meter Selector to BATT AMP position and verify battery is not discharging as indicated by the needle centered or to the left. A needle displaced to the right indicates the battery is discharging.
 - Place Meter Selector to BATT VOLT position and verify battery voltage is within normal limits (25-33 V).

NOTE

The BATTERY CHARGER Light provides an alternate indication of internal battery charger failure.

Emergency Power Check

EMER PWR Selector ON

Check:

- EMER PWR IN USE Light illuminates.
- AC and DC EMER BUS OFF Lights remain extinguished.
- Battery Volts and Amps within limits.

NOTES

- Ignore any random and intermittent indications of the VHF-1 Nav Select Panel Preselect Course Display.
- **TWA** (some 93xx and some 94xx airplanes) Emergency power switching may cause AHRS 1 to initiate realignment.

EMER PWR Selector OFF

Check:

- EMER PWR IN USE Light extinguishes.
- AC and DC EMER BUS OFF Lights remain extinguished.
- DC Volts / Amps Meter indicates battery is charging.

To Use APU Power

BATT Switch..... ON (locked)

The DC TRANSFER BUS OFF Light should be extinguished, and the DC EMER BUS OFF and AC EMER BUS OFF Lights should be illuminated.

APU START

After APU has stabilized at idle rpm:

APU PWR AVAIL Lights on Elec Pwr and Ground Service Elec Pwr Control Panels should be illuminated. It may be necessary to place the APU GEN Switch momentarily to the RESET position.

NOTE

Only one reset is permitted for each APU start.

To Power All Electrical Buses

APU PWR and EXT PWR Switches
(on Ground Service Elec Pwr Panel) OFF

NOTE

APU PWR and EXT PWR Switches (on Ground Service Elec Pwr Panel) must be OFF prior to connecting APU or external power to main AC buses.

APU L and R BUS Switches..... ON (one-at-a-time)

- APU Power In Use Lights should illuminate.
- The following lights should extinguish:
 - L AC BUS OFF
 - R AC BUS OFF
 - AC EMER BUS OFF
 - DC EMER BUS OFF
 - DC BUS OFF
- APU AC and DC LOAD Meters should indicate some load within normal limits.
- All electrical buses are now powered.
- Monitor APU AC load. Continuous operation of all electrical equipment may exceed limitations.

Indicator Selector..... BATT AMP

Rotate Indicator Selector to BATT AMP and observe that BATT AMP indication is zero to 40 amps to the left.

To Power Ground Service Bus Only

Ground Service APU PWR Switch ON

Ground Service EXT PWR Switch..... OFF

Ground Service APU Power In Use Light should illuminate.

To Use External Power

External Power Supply CONNECTED
EXT PWR AVAIL Lights should illuminate indicating external power is available, phase sequence is correct, and voltage / frequency in limits.
Indicator Selector (if desired) EXT PWR VOLT / FREQ

To Power All Electrical Buses

APU PWR and EXT PWR Switches
(on Ground Service Elec Pwr Panel) OFF

NOTE

APU PWR and EXT PWR Switches (on Ground Service Elec Pwr Panel) must be OFF prior to connecting APU or External Power to main AC load buses.

EXT PWR L and R BUS Switches ON (one-at-a-time)

- External Power In Use Lights should illuminate.
- The following lights should extinguish:
 - L AC BUS OFF
 - R AC BUS OFF
 - AC EMER BUS OFF
 - DC EMER BUS OFF
 - DC BUS OFF
- DC LOAD Meters should indicate within normal limits.

Indicator Selector BATT AMP
Rotate Indicator Selector to BATT AMP and observe that BATT AMP indication is zero to 40 amps to the left.

NOTE

BATT Switch must be on for battery charger operation.

To Power Ground Service Bus Only

GROUND SERVICE EXT PWR Switch ON
GROUND SERVICE APU PWR Switch OFF
Ground Service External Power In Use Light should illuminate.

Load Shedding with Overwing Heater Operation

Electrical power required by overwing heaters requires automatic shedding of some non-essential loads depending upon power source in use. Power source and load shed is as follows:

Sole Power Source Load Shed (automatically)

- EXT PWR Galley 4
- APU PWR Galley 4
- Single engine generator, all galleys and both overwing heaters

NOTE

If both engine generators are powering the right and left bus and the EXT PWR BUS Switches are in the ON position, with or without external power available, Galley 4 will shed.

AC Crosstie Check

NOTE

All electrical buses must be powered by engine-driven generators. If external or APU electrical power is connected, the EXT PWR and APU L and R BUS Power Switches must be OFF. AC Bus X Tie Switch must be in AUTO position.

- L GEN Switch OFF
 Observe left AC Load Meter indicates zero and right AC Load Meter indicates approximately double. Observe L GEN OFF Light is illuminated, and all BUS OFF Lights remain extinguished.
- L GEN Switch ON
 Observe left AC Load Meter indication increases, and right AC Load Meter indication decreases, both showing some load. All electrical system warning and caution annunciators should be extinguished.
- R GEN Switch OFF
 Observe right AC Load Meter indicates zero and left AC Load Meter indicates approximately double. Observe R GEN OFF Light is illuminated, and all BUS OFF Lights remain extinguished.
- R GEN Switch ON
 Move R GEN Switch to ON. Observe right AC Load Meter indication increases and left AC Load Meter indication decreases, both showing some load. All electrical system warning and caution annunciators should be extinguished.

Emergency Lighting for Non Emergencies

To Turn On Emergency Lighting

NOTES

- DO NOT use this procedure as a substitute for establishing / re-establishing normal electrical power to light the cockpit and cabin.
- If length of operation exceeds 5 minutes, emergency lighting battery packs may have to be replaced by Maintenance prior to further operation (depending upon the amount of charging time available until the next departure).
- Each minute of emergency lighting operation requires approximately one hour of recharge time.

■ **If normal power is available and EMER LTS Switch in OFF or ARM position:**

EMER LTS Switch ON

■ **If normal power is not available and EMER LTS Switch in OFF position:**

EMER PWR Selector ON

EMER LTS Switch ON

EMER PWR Selector OFF

To Turn Off Emergency Lighting

■ **If normal power is available:**

EMER LTS Switch OFF

■ **If normal power is not available:**

EMER PWR Selector ON

Batt Switch ON

EMER LTS Switch OFF

Batt Switch OFF

EMER PWR Selector OFF

Engines

Thrust Rating System Check

TEST Button.....PRESS and HOLD

Check:

- RAT – +12°C
- EPR Lim – 2.08
- Mode Button Lights – Extinguished
- NO MODE Light – Extinguished

TEST Button..... RELEASE

Check:

- RAT – AMBIENT
- EPR Lim – 2.00 (failure flag in view)
- NO MODE Light – Illuminated
- Mode Button Lights – Extinguished.

Any Mode Button.....PRESS

Extinguishes NO MODE Light.

Throttle Travel and Aural Warning Check

FLAPS / SLATSUP / RET

Both Throttles..... ADVANCE

- Check for freedom of movement to full travel.
- Ensure "*Fulap*" and "*Slat*" aural warnings are heard and takeoff warning horn sounds.

Both Throttles.....CLOSE

Fire Protection

Fire Warning Test (All Loops Switches in Both)

ENG and APU LOOPS Switches BOTH
ENG FIRE Handles IN / LIGHTS EXTINGUISHED
AGENT LOW Lights EXTINGUISHED
Loops Test Switches PRESS BOTH

CHECK RED LIGHTS IN EACH ENG FIRE Handle, all LOOP Lights, FIRE DETECTOR LOOP Light, APU FIRE Light, MASTER CAUTION and MASTER WARNING Lights illuminate.

Check fire bell sounds followed by an aural warning of either "*Fire left engine*" or "*Fire right engine*." Only one complete sequence required for valid test.

NOTE

No aural warning for APU.

Press FIRE BELL OFF Switch and check aural warnings cease.

Release test switches and check all lights extinguish.

Flight Controls

Stall Warning Test

STALL TEST SwitchSYS 1

Check:

- Stick shakers on both columns operate.
- STALL Lights illuminate flashing.
- STICK PUSHER PUSH TO INHIBIT Lights illuminate steady.
- Stall warning horn sounds for one second followed by the word "STALL."

Repeat test for SYS 2.

Maximum Speed Warning Test

MAX SPD WARN TEST SwitchSYS 1

Check that audio clacker sounds followed by the word "OVERSPEED."

Repeat test for SYS 2.

Stabilizer Trim Check

Captain's Control Wheel

Left Control Wheel Trim Switch NOSE UP / NOSE DN

Check that stabilizer does not move and aural warning does not sound.

CAUTION

Do not hold single switch position longer than 3 seconds.

Captain's Control Wheel

Right Control Wheel Trim Switch NOSE UP / NOSE DN

Check that stabilizer does not move and aural warning does not sound.

Captain's Control Wheel

Both Control Wheel Trim Switches NOSE UP / NOSE DN

Check that stabilizer moves in appropriate direction and aural warning.

First Officer's Control Wheel

Both Control Wheel Trim Switches NOSE UP / NOSE DN

Check that stabilizer moves in appropriate direction and aural warning.

Both LONG TRIM Handles NOSE UP / NOSE DN

Check both Handles in same direction, corresponding indicator movement, and aural warning.

Both ALT LONG TRIM Control Handles NOSE UP / NOSE DN

Check that stabilizer operates at a reduced rate in both directions and that alternate trim stops when handles are released.

Momentarily operate each ALT LONG TRIM Handle individually in each direction. Observe stabilizer does not move and aural warning does not sound when only one Handle is moved in either direction.

NOTES

- To obtain maximum service life, do not maintain switch positions longer than necessary to check response.
- If stabilizer moves with just one ALT LONG TRIM Handle activated, there is a malfunction in the alternate trim switch and maintenance action is required before dispatch.

Restoration of Slat Advisory Light Operation

Slat Advisory Lights are tested with the Annun / Digital Lts Test Button and cannot be pressed-to-test. If pressed, light unit will unlatch and light will not illuminate when tested or when slats have reached selected position.

Should a Slat Advisory Light fail to illuminate when tested or when a new slat position is selected, accomplish the following:

1. Press light unit to verify it is unlatched.

NOTE

If light should be illuminated, either by Annun / Digital Lts Test Button or slat position, light will momentarily illuminate, if bulbs are good, when pressed.

2. Pull light unit forward approximately 1/4 inch then, push in until light unit latches.

NOTE

If bulbs require replacement, pull light unit forward until it droops. Then light unit can be serviced with bulb #387 from Spare Bulb Kit.

If above fails to restore Slat Advisory Light operation, make a mechanical discrepancy entry in E6.

Flight Instruments

Switching to Alternate Static Source

CAUTION

A substantial change in airplane pitch attitude can take place when switching from primary to alternate source while autopilot is engaged in IAS or ALT HOLD. This is due to the difference in output from the CADC to the DFGC's.

Prior to selecting the alternate static source, disengage the autopilot.

EFIS Test

EFIS TEST Button.....PRESS and HOLD

Check for the following indications while TEST Button is pressed and held:

- On the PFD:
 - Radio Altimeter tape rises to 40 ft (± 5) then R/A FAIL legend is displayed.
 - Groundspeed data disappears.
 - G/S FAIL and LOC FAIL legends are momentarily displayed.
 - Glideslope Deviation Display appears then moves up one dot then disappears and G/S FAIL legend is displayed.
 - Localizer Deviation Display and Rising Runway symbol appear then move left one dot then disappears and LOC FAIL legend is displayed.
 - Marker beacon sequences from “O” (cyan) to “M” (amber) to “I” (white).
 - Attitude reference lines, F/S display and command bar disappear.
 - ATT FAIL, F/S FAIL and F/D FAIL legends are displayed.
- On the ND
 - Compass rose and digital heading disappear.
 - HDG FAIL, G/S FAIL and LOC FAIL legends are displayed.
 - HDG1 FAIL and HD2 FAIL legends are displayed (some airplanes).
 - MAP FAIL and VNAV FAIL legends are displayed (some airplanes).
 - Selected heading and DME information disappear.

EFIS TEST Button..... RELEASE

Compass Indicator

To synchronize the Compass Indicator:

Press and turn the Synchronizing Knob in the direction indicated by Compass Synchronizing Annunciator.

- When annunciator pointer indicates “+”, turn knob clockwise.
- When annunciator pointer indicates “•”, turn knob counterclockwise.

Instrument Tolerances

Altimeters – Ground Check

Set Captain's, First Officer's and Standby Altimeters to current MSL setting. The three Altimeters should indicate published field elevation, plus or minus the following:

Field Elevation – Feet ASL	Tolerance – Feet	
	Pilots' (CADC) Altimeters	Standby Altimeter
SL – 2000	-30 / +40	-20 / +50
2000 – 3000	-35 / +45	-25 / +55
3000 – 4000	-40 / +50	-30 / +60
4000 – 5000	-45 / +55	-35 / +65
5000 – 6000	-50 / +60	-40 / +70
6000 – 7000	-55 / +65	-45 / +75
7000 – 8000	-60 / +70	-50 / +80

These tolerances take into account the height of the Altimeter sensing device above the ground. As published field elevation is highest point on usable surface (runways), allowance should be made for any difference in elevation of ramp or point at which check is made.

If any altimeter is not within limits specified above, it must be entered in E6 and requires corrective action prior to takeoff.

After obtaining satisfactory check of Altimeters, reset Altimeters as appropriate.

Altimeter Spread (Difference between Captain's and First Officer's Altimeter Readouts)

Altitude (Feet)	Spread Should Be Within – Feet
SL	±60
25,000	±100
35,000	±120

Standby Attitude Indicator

The Standby Attitude Indicator should be less than three degrees in error in pitch and roll when compared to the ADI's, while the airplane is maintaining unaccelerated flight on a constant heading.

Mach / Airspeed Indicators

Mach Spread (Difference between the Captain's and First Officer's Mach Readouts)

Mach	Spread Should Be Within – Mach
0.80	0.02

Airspeed Spread (Difference between Captain's, First Officer's and Stby Airspeed Indicator Readouts)

Speed Range – Knots	Spread Should Be Within – Knots
80 – 149	4
150 – 249	6
250 – 350	10

- Mach Hold Tolerance – $\pm 0.02M$
- IAS Hold Tolerance – ± 5 knots

Vertical Speed Indicators

Difference between Captain's and First Officer's Vertical Speed Indicator readouts should not exceed $\pm 2\%$ of indicated vertical speed.

Fuel

Center Tank Fuel Pumps Check

All fuel tank boost pumps off (APU will continue to operate).

Switch each center tank boost pump on individually; check that both the L and R INLET FUEL PRESS LOW Lights extinguish. Switch off pump, check that the L and R INLET FUEL PRESS LOW Lights illuminate.

TWA CTR FUEL PRESS LO Message will illuminate after approximately 20 seconds when a single fuel pump is turned ON. Turning both pumps ON will extinguish the message.

Repeat for other pump.

Position pump being used for APU operation ON.

Fuel Quantity Test

NOTE

Do not accomplish fuel quantity test during refueling.

ZFW KnobPRESS and HOLD

Check current ZFW.

Channel Selector / Test KnobSELECT A or B

Channel Selector / Test KnobPRESS and HOLD

Airplanes without Aux Tanks

Each tank quantity display will indicate 3000 (± 100), Total Fuel display will indicate 9000 (± 300) and Gross Wt display will indicate ZFW plus Total Fuel quantity displayed.

Airplanes with Aux Tanks

Each tank quantity display will indicate 3000 (± 100), Total Fuel display will indicate 15000 (± 500) and Gross Wt display will indicate ZFW plus Total Fuel quantity displayed.

Channel Selector / Test Knob RELEASE

TWA NOTE

Fuel Quantity Test not required for (96xx) FMS airplanes.

Use of Fuel Heat

Fuel temperature of 0°C or below or FUEL FILTER PRESS DROP Light determines which engine will require fuel heat. When fuel heat is applied to more than one engine, momentarily position FUEL HEAT Switches to ON one at a time, checking engine parameters have stabilized before applying fuel heat to subsequent engine.

Check respective fuel temperature rises when fuel heat is applied, and fuel temperature drops when FUEL HEAT ON Light extinguishes.

Takeoff and Approach

No later than one minute prior to takeoff or approach if indicated fuel temperature is 0°C or less, it is recommended that fuel heat be turned on for one cycle. Fuel heat must remain OFF during takeoff, approach / landing, and go-around.

In Flight

When any FUEL FILTER PRESS DROP Light illuminates:

Refer to QRH – ENG – L or R FUEL FILTER PRESS DROP Light.

Ground Transfer of Fuel

If the distribution of the fuel on board does not agree with the distribution specified by the Load Plan, a ground transfer of fuel may be required.

Establish communications.

Fuel Boost Pump Switches (supplying tank) ON

All Other Fuel Boost Pump Switches..... OFF

FUEL X FEED Lever (if transferring fuel from left tank)..... ON

Ground Crew

Defuel Valve OPEN

Fill Valve (affected tank) OPEN

Fuel Quantities MONITOR

When Fuel Transfer Completed:

Fuel Boost Pump Switches (supplying tank) OFF

FUEL X FEED Lever (if transferring fuel from left tank)..... OFF

Ground Crew

Defuel Valve CLOSED

Fill Valve CLOSED

Hydraulics

Hydraulic System Check

CAUTION

L and R ENG REVERSE UNLOCK Lights must be extinguished and Reverse Levers in forward thrust before turning on any hydraulic pump.

Eng Hyd Pump Switches..... HI

Aux Hyd Pump Switch..... OVRD then ON

Check:

- Right Hyd Press Gage indicates a rise in pressure in OVRD position and within the green band in ON position.
- R HYD PRESS LOW Light extinguished.

Trans Hyd Pump Switch..... ON

Check:

- Left Hyd Press Gage indicates above 2000 psi.
- L HYD PRESS LOW Light is extinguished.

Hydraulic Fluid Quantities CHECK

When pressure indicates above 2000 psi, full indications are:

- Left System – 9.8 qts
- Right System – 11.3 qts or

Refill required if, with systems pressurized to 2000 psi or greater:

- Left System – 7.5 qts or less
- Right System – 8.5 qts or less

TWA NOTE

System Display Panel (SDP) displays values in full quarts. Refill is required when:

- Hydraulic Quantity Low Light illuminates, or
- Left system displays 8 qts or less,
- Right System displays 9 qts or less.

Trans Hyd Pump Switch.....OFF

Aux Hyd Pump Switch.....OFF

NOTES

- Hydraulic pressure may fluctuate during transfer pump operation.
- If either HYD PRESS LOW Light is illuminated and system pressure is normal, request Maintenance to check the respective Spoiler Depressurization Valve is in SPOILER ON position.

An off scale high quantity indication may be observed when the hydraulic system is depressurized (pump off). Therefore, an accurate quantity check can only be accomplished with a pressurized system. Should an off scale high quantity indication be observed, make an info to Maintenance entry in the E6.

Landing Gear

Anti-Skid Test

- Anti-Skid Switch – Check in the ARM position.
Check that all anti-skid lights are extinguished.
- Anti-Skid Test Ckt Switch – TEST
Check that all anti-skid lights illuminate.
- Anti-Skid Test Ckt Switch – Release
Check that all anti-skid lights extinguish.

Tire Inspection / Replacement Guide

This guide provides information for the most commonly found tire wear / damage conditions. A tire should be reported in the E6 for any of the following conditions. Tire replacement and tire replacement exception criteria will be per the Maintenance, General Procedures Manual (GPM).

Main Tire Tread Wear Limits

Three, Four or Five Groove Tires

Allow tires to be worn to the tread reinforcing plies on 25% of the tire tread circumference.

Six Groove Tires

Allow tires to be worn to the tread reinforcing plies on 25% of the tire tread circumference as long as none of the four center grooves are worn to full design depth.

Nose Tire Tread Wear Limits

Two Groove Tires

Allow tires to be worn to the tread reinforcing plies on 25% of the tire tread circumference.

Navigation

VOR Ground Check Using VOT

- Select frequency of test facility and identify.
- Set course indicator to 180°.
- "TO-FROM" flag should indicate "TO."
- Course deviation bar of ND should center. If not centered, adjust course indicator until bar is centered. Adjustment should not exceed $\pm 4^\circ$.
- Set selected course indicator 10° (in each direction) from the established bearing; course deviation bar should deflect two dots or more.
- Check respective RMI needle points to 180°. The spread between the RMI needle and the ND or HSI course should be no greater than 5°.

The spread between the single vs. double needles on RMI with both VHF NAV's tuned to the same station should be no greater than 8°.

TWA AHRS Alignment (some 93xx and some 94xx)

AHRS Alignment is initiated when associated AC bus is powered. Both left and right busses must be powered within 10 seconds to enable AHRS to align. Alignment requires about 45 seconds. Satisfactory AHRS alignment is indicated by normal displays on PFD and ND, and absence of ATT FAIL and HDG FAIL messages.

If either AHRS aligns in BASIC mode (AHRS BASIC MODE annunciator illuminated) or (BASIC ATT annunciator illuminated), initiate another alignment by switching power off for one second, then back on again. A normal alignment is also possible after changing to a new power source (APU or engine generators). Occasionally, AHRS may not align in the normal mode; however, performance or AHRS meets all dispatch requirements in either mode.

CAUTION

Airplane must not be moved while ground alignment is in progress.